



SXblue

USER MANUAL

WWW.SXBLUEGPS.COM

Copyright Notice

© Copyright 2017 SXblue GPS inc. All rights reserved. No part of this manual may be stored in a retrieval system, transmitted, or reproduced by any means, including, but not limited to photocopy, photograph, digitizing, or otherwise, without the prior written permission from SXblue GPS inc.

Trademarks

The SXblue GPS logo, SXblue GPS™, SXblue GNSS™, SXblue L1/L2 GNSS™, SXblue II+ GPS™, iSXblue II+ GPS™, SXblue II-B GPS™, SXblue II-L GPS™, SXblue II+ GNSS™, iSXblue II+ GNSS™, SXblue III+ GNSS™, iSXblue III+ GNSS™, SXblue III-L GNSS™, SXblue Platinum™ and SXblue Platinum AG™ are trademarks of SXblue GPS inc. The Bluetooth™ trademarks are owned by Bluetooth SIG Inc., USA. All other trademarks are the property of their respective owners.

FCC Notice

This device complies with Part 15 of the FCC Rules. Operation is subject to the following two conditions:

- (1) this device may not cause harmful interference, and
- (2) this device must accept any interference received, including interference that may cause undesired operation.

NOTE: This equipment has been tested and found to comply with the limits for a Class B digital device, pursuant to part 15 of the FCC Rules. These limits are designed to provide reasonable protection against harmful interference in a residential installation. This equipment generates, uses and can radiate radio frequency energy and, if not installed and used in accordance with the instructions, may cause harmful interference to radio communications. However, there is no guarantee that interference will not occur in a particular installation. If this equipment does cause harmful interference to radio or television reception, which can be determined by turning the equipment off and on, the user is encouraged to try to correct the interference by one or more of the following measures:

- Reorient or relocate the receiving antenna.
- Increase the separation between the equipment and receiver.
- Connect the equipment into an outlet on a circuit different from that to which the receiver is connected.
- Consult the dealer or an experienced radio/TV technician for help.

SXblue GPS

10700 Secant

Montreal, Quebec, Canada H1J 1S5

Telephone number: +1-514-354-2511

Toll Free: +1-800-463-4363 (North America)

Fax number: +1-514-354-6948

E-mail address: info@sxbluegps.com

Web Sites: www.sxbluegps.com

SXblue GPS Limited Warranty

SXBlue GPS hereby warrants solely to the end purchaser of the Products, subject to the exclusions and procedures set forth herein below, that the Products sold to such end purchaser shall be free, under normal use and maintenance, from defects in material and workmanship for a period of 2 years from delivery date to such end purchaser.

Repairs and replacement components are warranted, subject to the exclusions and procedures set forth below, to be free, under normal use and maintenance, from defects in material and workmanship for 90 days from performance or delivery, or for the balance of the original warranty period, whichever is greater. Battery packs are warranted for a period of 90 days.

Purchaser's Exclusive Remedy

The end purchaser's exclusive remedy under this warranty shall be limited to the repair or replacement at the option of SXBlue GPS, of any defective Products or components thereof. The end user shall notify SXBlue GPS or a SXBlue GPS approved service center immediately of any claimed defect. Repairs shall be made through a SXBlue GPS approved service center only.

Exclusions

SXBlue GPS does not warrant damage occurring in transit or due to misuse, abuse, improper installation, neglect, lightning (or other electrical discharge) or fresh/salt water immersion of Products. Repair, modification or service of SXBlue GPS Products by any party other than a SXBlue GPS approved service center shall render this warranty null and void. SXBlue GPS does not warrant claims asserted after the end of the warranty period.

SXBlue GPS does not warrant or guarantee the precision or accuracy of positions obtained when using Products. Products are not intended for primary navigation or for use in safety of life applications. The potential accuracy of Products as stated in SXBlue GPS literature and/or Product specifications serves to provide only an estimate of achievable accuracy based on:

- Specifications provided by the US Department of Defence for GPS Positioning
- GPS OEM Receiver specifications of the appropriate manufacturer (if applicable)
- DGPS service provider performance specifications.

SXBlue GPS reserves the right to modify Products without any obligation to notify, supply or install any improvements or alterations to existing Products.

No Other Warranties

The foregoing warranty is exclusive of all other warranties, whether written, oral, implied or arising by statute, course of dealing or trade usage, in connection with the design, sale, installation, service or use of any products or any components thereof, including, but not limited to, any warranty of merchantability or fitness for a particular purpose.

Limitation of Liability

The extent of SXBlue GPS's liability for damages of any nature to the end purchaser or any other person or entity whether in contract or tort and whether to persons or property shall in no case exceed, in the aggregate, the cost of correcting the defect in the product or, at SXBlue GPS's option, the cost of replacing the defective item.

In no event will SXBlue GPS be liable for any loss of production, loss of profits, loss of use or for any special, indirect, incidental, consequential or contingent damages, even if SXBlue GPS has been advised of the possibility of such damages. Without limiting the foregoing, SXBlue GPS shall not be liable for any damages of any kind resulting from installation, use, quality, performance or accuracy of any products.

Governing Legislation

To the greatest extent possible, this warranty shall be governed by the laws of the Province of Quebec (Canada). In the event that any provision hereof is held to be invalid by a court of competent jurisdiction, such provision shall be severed from this warranty and the remaining provisions shall remain in full force and effect.

Obtaining Warranty Service

In order to obtain warranty service, the end purchaser must bring the Product to a SXBlue GPS approved dealer, along with the end purchaser's proof of purchase or with the Extended Warranty Certificate. For any questions regarding warranty service or to obtain information regarding the location of any of SXBlue GPS's dealers, contact SXBlue GPS at:

SXblue GPS inc.
10700, Secant Street
Montreal, Quebec, H1J 1S5
Canada

Telephone number:	+1-514-354-2411
Toll Free:	+1-800-463-4363 (North America)
Fax number:	+1-514-354-6948
E-mail address:	info@sxbluegps.com

Table of Contents

List of Figures.....	viii
List of Tables.....	ix
Organization	xi
Customer Service	xi
World Wide Web Site	xii
Document Conventions	xii
Notes, Cautions, and Warnings.....	xiii
1. Getting Started.....	13
1.1 Unpacking Your SXblue Receiver	13
1.2 Getting Familiar with your SXblue	14
1.2.1 System Overview.....	14
1.2.2 Battery Pack.....	16
1.2.3 Precision and Survey Antenna	17
1.2.4 GNSS Antenna Cable Configuration	18
1.2.4.1 SXblue 12/24 volts with GNSS Precision Antenna	18
1.2.4.2 SXblue 12/24 volts with GNSS Survey Antenna	18
1.2.4.3 SXblue II, SXblue III and SXblue Platinum with GNSS Precision Antenna ..	19
1.2.4.4 SXblue II, SXblue III and SXblue Platinum with GNSS Survey Antenna.....	19
1.3 Getting Ready for the Field.....	19
1.3.1 Default Parameters.....	20
1.3.2 Configuring Bluetooth Communication	22
1.3.2.1 Android OS.....	23
1.3.2.2 Apple iOS	25
1.3.2.3 Windows 10.....	26
1.3.2.4 Windows Mobile CE	28
1.3.3 Installing the USB Drivers for Microsoft Windows	30
1.4 In the Field	32
1.4.1 Setting up for Sub meter Work	33
1.4.1.1 Using the Nylon Carrying Case	33
1.4.1.2 Using the Soft hat.....	34
1.4.2 Setting up for RTK Work.....	35
1.4.2.1 Using the Precision Antenna Mounting Plate	35
1.4.2.2 Range pole Setup.....	36
1.4.3 Antenna Phase Center	37
1.4.3.1 GNSS Precision Antenna	38
1.4.3.2 GNSS Survey Antenna.....	38
1.4.4 Definition of the LED Indicators	39
1.4.5 GIS Field Data Collection and Datum Considerations	40
1.4.5.1 Generic Field Data Collection Software Configuration.....	41
1.4.5.2 General Guidelines for Sub meter GIS Field Data Collection	42
1.4.5.3 Basic Knowledge for RTK Field Work	42
1.4.5.4 What to Know About Atlas Services (SXblue Platinum only).....	44
1.4.6 Available Software and Utilities	45
1.4.6.1 SXblue Config.....	45

1.4.6.2	SXblue RTN.....	45
1.4.6.3	SXblue Server	45
1.4.6.4	SXblue Mirror.....	45
1.4.6.5	RINEX Converter.....	46
1.4.6.6	SXblue GPS EZSurv	46
1.4.6.7	SXblue GPS FieldGenius	46
1.4.6.8	ESRI Collector	46
2.	Features and Performance	47
2.1	GPS	47
2.1.1	Satellite Tracking	47
2.1.2	Positioning Accuracy	47
2.1.3	Update Rates	48
2.2	SBAS	48
2.2.1	Automatic Tracking and Ranging.....	49
2.2.2	SBAS Performance.....	49
2.3	DGPS RadioBeacon (for SXblue II-B)	50
2.3.1	RadioBeacon Range.....	51
2.3.2	Signal Reception.....	51
2.4	Single Baseline RTK and RTK Networks	52
2.4.1	Single Baseline RTK.....	53
2.4.2	RTK Networks.....	54
2.5	Atlas GNSS Global Correction Services (for SXblue Platinum)	55
2.5.1	System Overview.....	55
2.5.2	Signal Reception.....	56
2.5.3	Automatic Tracking and Performance	57
2.5.4	Available Services	57
2.6	COAST™ and SureTrack™ Technologies	58
2.7	Real-Time Differential Options.....	59
2.7.1	The “MFA” Application	59
2.7.2	The L-Band Application	60
2.7.3	RTK Differential options.....	60
2.8	Post Processing.....	60
2.9	Evaluating the SXblue Performance.....	61
2.10	Communication.....	63
2.10.1	Interface.....	63
2.10.2	Bluetooth, USB and Serial Ports	63
2.10.3	Event Marker, 1 Pulse per Second and 5Vdc Power	65
2.10.3.1	One Pulse per Second (1PPS).....	65
2.10.3.2	Event Marker Input (EM)	65
2.10.3.3	5 volts DC Output (PWR)	65
2.11	Environmental Requirements	66
3.	Advanced Operations	67
3.1	Communicating with the SXblue receiver.....	67
3.1.1	NMEA 0183 Interface	67
3.1.2	Binary Interface.....	68
3.1.3	RTCM SC-104 Protocol	68
3.2	Configuring the SXblue Receiver	69
3.2.1	Using SXblue Config.....	70

3.2.2 Activating an Option.....	74
3.3 DGPS RadioBeacon Operation (SXblue II-B GPS).....	76
3.3.1 Automatic Mode	76
3.3.2 Manual Mode.....	77
3.3.3 Database Mode.....	77
3.3.4 Evaluating Performance	78
4. Troubleshooting.....	80
4.1 Troubleshooting Checklist	80
4.2 Using the LEDs to Troubleshoot.....	81
Appendix A - Interface	84
Appendix B - Introduction to GNSS and DGPS Services.....	86
Appendix C - Resources.....	99
Index	103

List of Figures

Figure 1-1 SXblue Series Main Components.....	15
Figure 1-2 Battery contacts	16
Figure 1-3 GNSS/Beacon/L-band Antenna.....	17
Figure 1-4 Cable for GNSS Precision Antenna and SXblue 12/24 volts	18
Figure 1-5 Cable for GNSS Survey Antenna and SXblue 12/24 volts	18
Figure 1-6 Cable for GNSS Precision Antenna and SXblue receiver	19
Figure 1-7 Cable for GNSS Survey Antenna and SXblue receiver.....	19
Figure 1-8 Carrying Case.....	33
Figure 1-9 Removing the Magnet Adaptor.....	34
Figure 1-10 Using the Softhat	34
Figure 1-11 Using the Antenna Mounting Plate	35
Figure 1-12 Using the L-Shaped Bracket.....	36
Figure 1-13 Mounting on a Rangepole	37
Figure 1-14 Phase Center – GNSS Precision Antenna (GESXB3GLANT)	38
Figure 1-15 Phase Center – GNSS Survey Antenna (GESXGNSSSANT31)	38
Figure 1-16 SXblue Series Front Panel	39
Figure 2-1 Sample Extrapolated Ionospheric Grids	50
Figure 2-3 RS-232 Connector Pin-out	64
Figure B-1 Serial Interface	84
Figure B-3 RTCM Data Input to Serial Port	85
Figure C-1 WAAS Ground Segment (end of 2007)	94
Figure C-2 EGNOS Ground Segment (end of 2007)	94
Figure C-3 Worldwide SBAS Coverage	96
Figure C-4 Worldwide SBAS Ionospheric Coverage	97
Figure C-5 Broadcast and Extrapolated Ionospheric Correction Map	98

List of Tables

Table 1-1 Default Applications and Performances.....	20
Table 1-2 Default Port Settings.....	21
Table 1-3 Default GPS NMEA Message Output.....	21
Table 1-4 Default Parameters.....	22
Table 1-5 LED Indicators Definitions.....	40
Table 2-1 Differential and Global Options.....	59
Table 2-2 Horizontal Accuracy Probability Statistics.....	61
Table 2-3 Horizontal Accuracy Statistic Conversions.....	61
Table 2-4 Serial Port Pin-out, RS-232C Interface Level.....	64
Table 3-2 Date Codes and Enabled Applications.....	79
Table 7-1 Troubleshooting.....	80
Table 7-2 LED Functions.....	82
Table C-1 Worldwide SBAS Constellation (end of 2007).....	97

Preface

Welcome to the SXblue Series User Manual and congratulations on purchasing this high-performance GPS (GNSS) receiver.

The SXblue Series provides a high level of performance, delivering sub-meter positioning using either the built-in SBAS demodulator (all models), Atlas[®] (SXblue Platinum with L-band correction), Radio Beacon DGPS (SXblue II-B GPS) or external corrections (all models), at up to 20Hz output (optional). The SXblue Series features raw measurement output for post-processing applications, delivers excellent phase measurement quality for cm post-processed and single frequency RTK applications. It also features independent Bluetooth, USB (except SXblue 12/24 volts) and serial communications.

This document is meant to assist a customer in becoming familiar with the SXblue functionality and system operation, but also with GPS (GNSS) / SBAS / Atlas[®] / Radio Beacon / DGPS / RTK concepts.

The chapters that follow provide detailed information on the SXblue receivers, including the hardware and software interface, in addition to various descriptions of technologies and features that it supports.

Some notable features of the SXblue Series are:

- Multi-channel GPS/GNSS engine (up to 3 channels dedicated to SBAS tracking)
- Tracks L1 GPS signal with optional Multi-Frequency and Multi-Constellation
- 1 channel Atlas[®] (SXblue Platinum models)
- 2-channel Radio Beacon parallel tracking (SXblue II-B GPS)
- Sub-meter (2dRMS) horizontal accuracy 95% with SBAS
- RAW measurement output (via documented binary messages) or RINEX converter
- COAST[™] technology provides consistent performance with old correction data and guarantees an all-day DGPS solution even in forestry applications (with suitable SBAS or Atlas[®] coverage)
- Real Time Kinematic (RTK) positioning: the highest form of navigational accuracy for GNSS receivers
- SBAS (WAAS/EGNOS/MSAS/GAGAN/etc.), Atlas[®], Beacon, and external differential sources depending on model
- Quick time to first fix
- One internal Serial Port Profile (SPP) Bluetooth module allows a modular GPS system configuration with the use of any up-to-date handheld/tablet/computer and software combination
- One USB 2.0 compliant port (except SXblue 12/24 volts) and One full-duplex Serial port, can be used to configure the product, or to output/receive RTCM corrections and/or NMEA messages
- Integrated Li-Ion battery for full day operation (except SXblue 12/24 volts)
- Position and RAW measurement update rates of 1Hz (standard) and up to 20Hz (optional)

- SureTrack technologies (GNSS models only) enable the use of GLONASS satellites in the code DGPS and phase RTK solution respectively, without receiving GLONASS corrections from the differential source (SBAS, RTK, GPS-only base station, etc).

Organization

This manual contains the following chapters:

Chapter 1: Getting Started - provides information to help you get your SXblue receiver running quickly.

Chapter 2: Features and Performance - introduces you to the SXblue receiver and some of its main features.

Chapter 3: Advanced Operations - provides details on the fundamental operating modes of the SXblue receiver and describes how to configure and operate the receiver.

Chapter 4: Troubleshooting - provides you with diagnostic information to aid in determining a source of difficulty for a particular installation.

Appendix A – Interface - provides instructions to interface the SXblue receiver with external devices.

Appendix B – Introduction to GNSS and DGPS Services - provides both general and specific information relating to GPS, GLONASS, SBAS and RTK Networks.

Appendix C – Resources - This appendix lists a number of different resources that may be useful for the advanced user.

The **Index** provides a listing of the locations of various subjects within this manual.

Customer Service

If you encounter problems during the installation or operation of this product, or cannot find the information you need, please contact your dealer, or SXblue GPS Customer Service. The contact numbers and e-mail address for SXblue GPS Customer Service are:

Telephone number: +1-514-354-2511
Toll Free: +1-800-463-4363 (North America)
Fax number: +1-514-354-6948
E-mail address: info@sxbluegps.com

Technical Support is available from 8:30 AM to 5:00 PM Eastern Time, Monday to Friday.

To expedite the support process, please have the product model and serial number available when contacting SXblue GPS Customer Service or Technical Support. Technical Support inquiry can be sent by email at support@sxbluegps.com or by filling an **Online Request** under Technical Support tab from www.sxbluegps.com web site.

In the event that your equipment requires service, we recommend that you contact your dealer directly. However, if this is not possible, you must contact SXblue GPS Customer Service or/and use the **Return Merchandise** form under Technical Support tab from www.sxbluegps.com web site. If you are returning a product for repair, you must also provide a fault description.

World Wide Web Site

SXblue GPS maintains World Wide Web home pages at the following addresses:
www.sxbluegps.com.

A corporate profile and product information are available at these sites under the Geomatics section.

Document Conventions

Bold is used to emphasize certain points.

Unless otherwise specified, the name **SXblue** is used for simplicity to describe common features of all three models: SXblue GPS, SXblue GNSS, SXblue L1/L2 GNSS, SXblue II+ GPS, iSXblue II+ GPS, SXblue II-L GPS, SXblue II-B GPS, SXblue II+ GNSS, iSXblue II+ GNSS, SXblue III+ GNSS, iSXblue III+ GNSS, SXblue III-L GNSS, SXblue Platinum™ and SXblue Platinum AG™.

Notes, Cautions, and Warnings

Notes, Cautions, and Warnings stress important information regarding the installation, configuration, and operation of the SXblue receiver.

Note - Notes outline important information of a general nature.

Cautions - Cautions inform of possible sources of difficulty or situations that may cause damage to the product.

Warning - Warnings inform of situations that may cause harm to you.

1. Getting Started

The purpose of this chapter is to help you get your SXblue receiver running quickly. This chapter is not intended to replace the balance of this user manual and it assumes that you have a reasonable amount of knowledge with installation and operation of GPS/GNSS navigation systems.

If you are new to GPS, GNSS, SBAS, RadioBeacon, DGPS, and RTK or Atlas® Services, we recommend that you consult Appendix B for further information on these services and technologies.

1.1 Unpacking your SXblue Receiver

If you find that any of these items listed below are damaged due to shipment, please contact the freight carrier immediately for assistance.

When you unpack your SXblue receiver, please ensure that it is complete by comparing the parts received against the packing slip. Unless your system has been equipped differently than a standard SXblue, you should find the following parts in your package:

- One SXblue Receiver with battery pack (except SXblue 12/24 volts)
- One Precision Antenna (GPS/GNSS/L-Band, GPS/Beacon, or GNSS Survey Antenna)
- One Antenna cable
- One RS-232 cable
- One USB cable (except SXblue 12/24 volts)
- One Li-Ion Battery Charger (except SXblue 12/24 volts)
- One Soft Hat for antenna (except SXblue 12/24 volts)
- One Nylon Carrying Case

Note - If, for some reason, you find a discrepancy between your packing slip and the contents of your shipment, please contact the authorized reseller with which you placed your order immediately.

1.2 Getting Familiar with your SXblue

The SXblue is composed of three main parts:

- The receiver with user interface (LED's, Communication ports, Antenna connector)
- The battery pack with Battery Fuel Gauge (except SXblue 12/24 volts)
- The external precision antenna with cable

1.2.1 System Overview

Figure 1-1 shows the various components of the SXblue receiver and battery pack (the images shown as examples are from SXblue II GPS receiver).

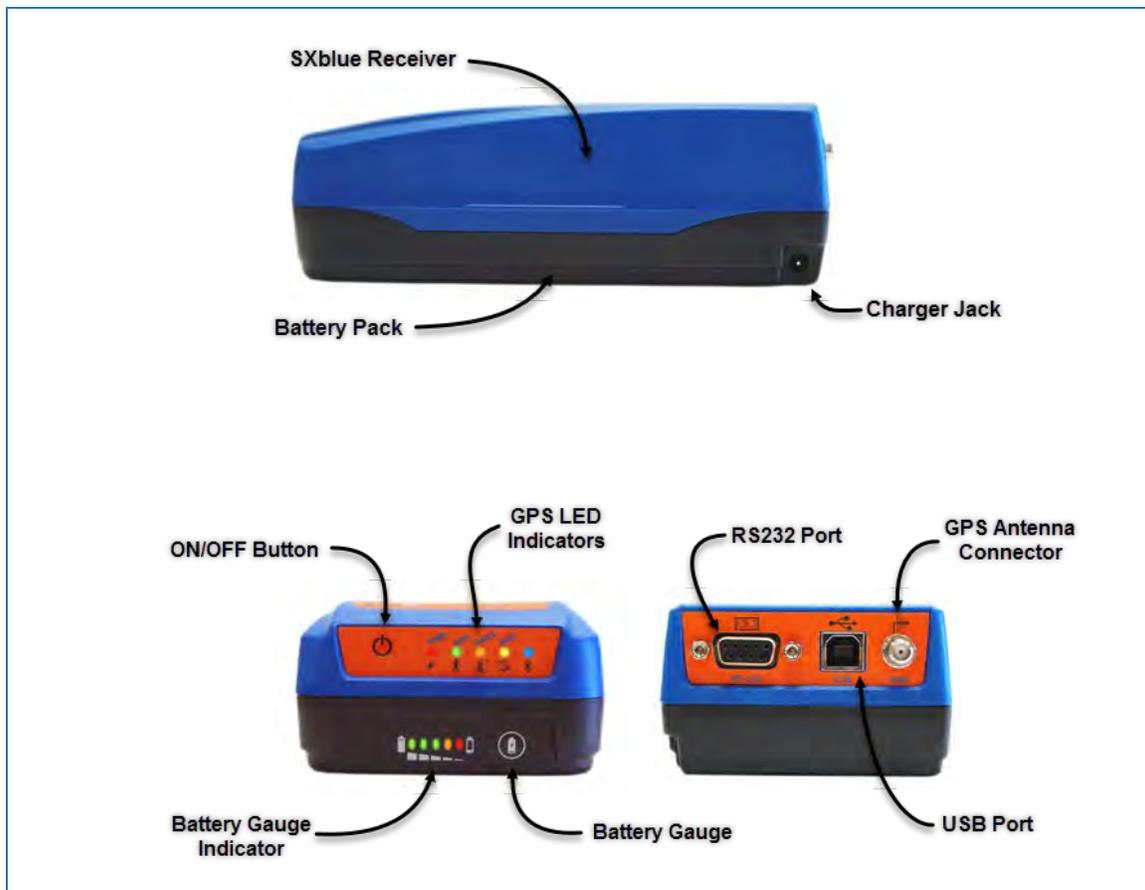



Figure 1-1 SXblue Series Main Components

The connections required by the SXblue receiver are very straightforward. All cables necessary for complete operation are provided.

- The RS-232 port is a D-Sub 9-pin female connector (differs for SXblue 12/24 volts)
- The USB port is a Type-B female connector (not available for SXblue 12/24 volts)
- The Bluetooth port is a Class 1 type.

The SXblue receiver offers three (two for SXblue 12/24 volts) communication options: Serial RS-232, USB (not available for SXblue 12/24 volts) and Bluetooth. In order to use the USB port, a driver (available on our web site) must be installed on your computer. Refer to section 1.3 for instructions on how to install the drivers. In order to use the Bluetooth (wireless) communication of the SXblue receiver, you must use a Bluetooth-enabled device or computer. If you have a device or computer that does not support Bluetooth natively, you can supplement your computing device with a Bluetooth card (CF, PCMCIA, SD) or USB dongle. When configuring your Bluetooth device for communication with the SXblue receiver, make sure that pairing (or bonding) with password (or passkey) is not activated. A miniature DIP switch (see Figure 1-2) allows powering off the Bluetooth radio when the receiver is operated in places where the use of wireless communication is prohibited. Refer to section 1.3.2 for more information on sample Bluetooth setups.

1.2.2 Battery Pack (not available for SXblue 12/24 volts)

The Lithium-Ion battery pack attaches to the receiver with four thumb screws. Modular contacts are used to supply power to the receiver. Even though the Li-Ion battery pack has a built-in protection circuitry, care must be taken not to short the contacts on the battery pack.

Also, membrane vents are used on both the receiver and battery pack. These small holes should not be punctured, obstructed or covered by labels or stickers.

The battery pack features an intelligent battery “fuel gauge” that shows the level of charge (see Figure 1-1).

On initial usage, it might take one or two charge/discharge cycles for the gauge to reflect the proper charge level. When unit is not used for an extended period of time, it is normal that the battery pack discharges. The field autonomy of the pack is roughly 9.5 to 15 hours depending on the model and after 500 cycles, battery capacity starts decreasing to about 80%.

Since the SXblue receiver (except SXblue 12/24 volts) use Li-Ion battery chemistry, there is no memory effect as for NiMH or NiCad batteries; therefore it is not necessary to discharge the pack before recharging it. **Only proper Li-Ion battery charger must be used with the SXblue battery.** Using any other type of charger might result in explosion and injuries. The SXblue battery pack specification is: 2s2p, 7.2V, 3,900mAh Li-Ion. If using a different charger than the supplied charger, the following specifications must be followed: 2-cell Li-Ion charger, maximum current of 2A, charger plug to fit a 1.7mm positive center-pin jack with 5mm OD.

Charge time with supplied charger is about 4 to 5 hours when battery is empty. The charger is equipped with a charge indicator LED that will switch to a steady Green when battery is fully charged. The charger supports input voltages of up to 240VAC.

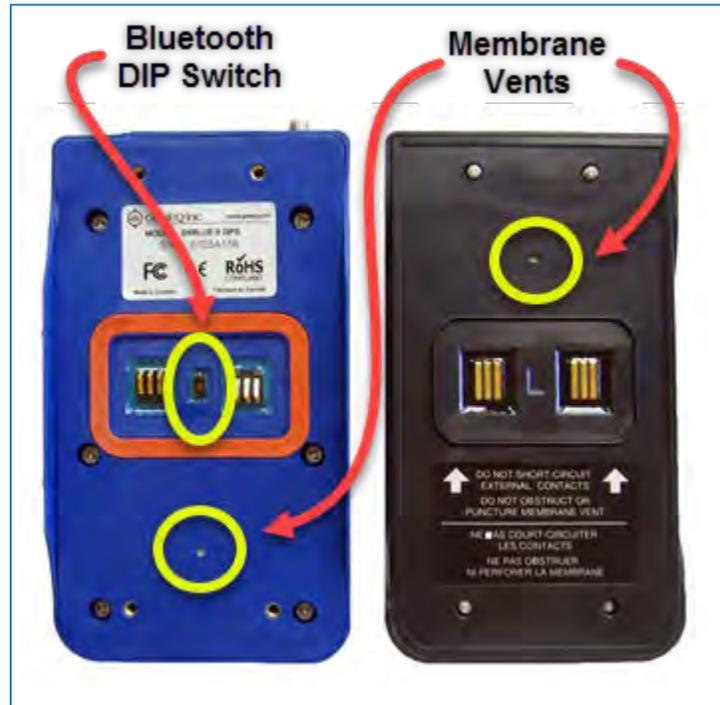

Figure 1-2 Battery contacts

Warning – Use only supplied charger with the SXblue battery pack.

Do not disassemble, modify, puncture, mutilate or incinerate or heat battery pack.

Do not store the battery inside vehicles in hot weather.

Do not short-circuit battery contacts.

Do not puncture or obstruct membrane vents.

Battery should be stored at room temperature charged to about 30-50% capacity.

Charge battery once every 3 months to prevent overdischarge.

Battery must be charged only when its temperature has settled between 0°C and 45°C.

Temperature range over which battery can be discharged is between -20°C and 60°C. Use of the battery outside of the specified range reduces performance and life expectancy.

When battery reaches end-of-life, insulate terminals with adhesive tape or similar material before disposal.

1.2.3 Precision and Survey Antenna

The Precision GPS/GNSS/L-Band, GPS/Beacon, or GNSS Survey antenna supplied with the SXblue Series have been designed to provide reliable, stable and consistent sub-meter and centimeter positioning. The GPS/GNSS/L-Band antenna feature a female SMA connector, whereas the GPS/Beacon and GNSS Survey antenna feature a TNC female connector (see Figure 1-3). The bottom part of the GPS/GNSS/L-Band antenna is magnetic and can be detached by removing the 4 screws. Magnetic mount is optional for the GPS/Beacon and GNSS Survey antenna.

Using different antenna than the ones supplied, might degrade the performance of the SXblue receiver. Shall a different antenna be used, a maximum of 29dB gain is recommended. When using longer antenna cable, it is important to take into account the cable loss (dB/m) to allow at least 21dB at the RF input of the receiver.



Figure 1-3 GNSS/Beacon/L-band Antenna

Caution – By default, the SXblue receiver supplies 5.0 VDC across its RF connector to power an active GPS antenna’s low noise amplifier (LNA). Connection to a GPS antenna that doesn’t support a 5 VDC input could damage the antenna.

1.2.4 GNSS Antenna Cable Configuration

The cable between GNSS antenna and SXblue receiver depends on the connector type of antenna and receiver.

1.2.4.1 SXblue 12/24 volts with GNSS Precision Antenna

The cable required for this configuration is equipped with SMA (male) connector which goes to the GNSS Precision antenna and BNC (male) connector which goes to SXblue 12/24 volts receiver (see Figure 1-4).

1.2.4.2 SXblue 12/24 volts with GNSS Survey Antenna

The cable required for this configuration is equipped with TNC (male) connector which goes to the GNSS Survey antenna and BNC (male) connector which goes to SXblue 12/24 volts receiver. The TNC (male) connector can be straight or right angle (see Figure 1-5).

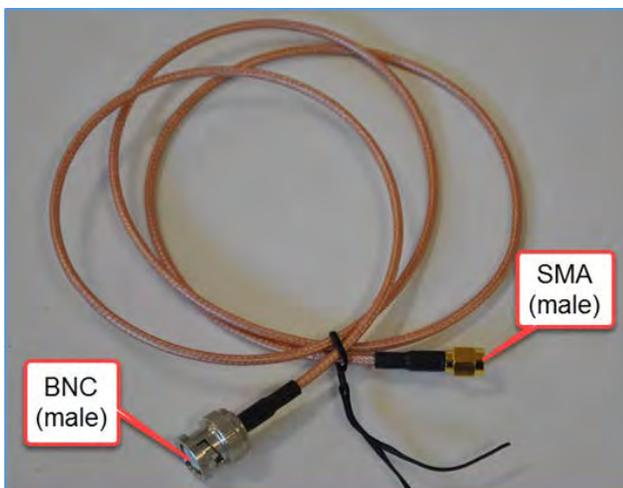

Figure 1-4 Cable for GNSS Precision antenna and SXblue 12/24 volts receiver



Figure 1-6 Cable for GNSS Precision antenna and SXblue receiver

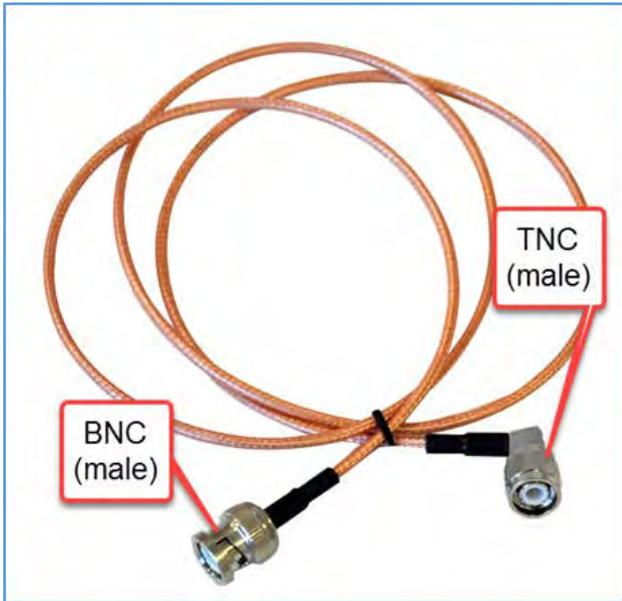

Figure 1-5 Cable for GNSS Survey antenna and SXblue 12/24 volts receiver

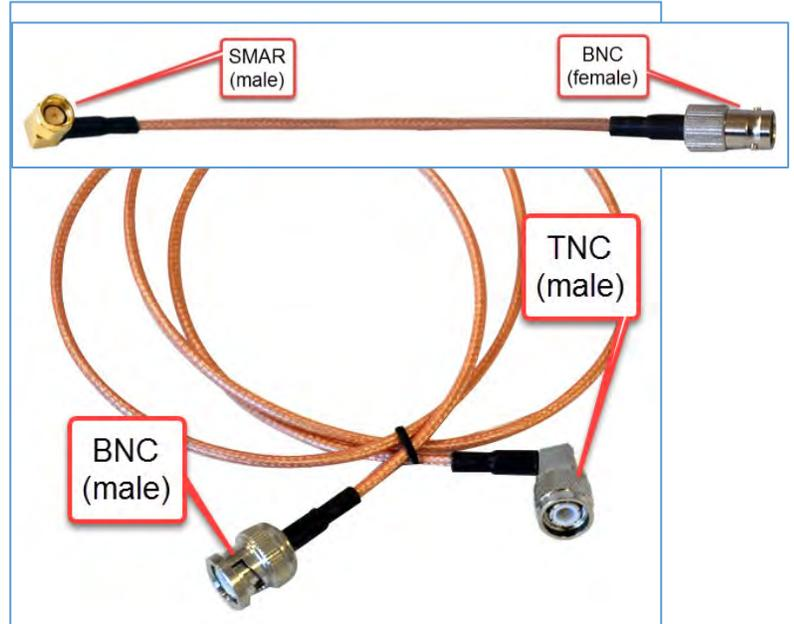

Figure 1-7 Cable for GNSS Survey antenna and SXblue receiver

1.2.4.3 SXblue II, SXblue III and SXblue Platinum with GNSS Precision Antenna

The cable required for this configuration is equipped with SMA (male) connector which goes to the GNSS Precision antenna and SMAR (male) right angle connector which goes to SXblue receiver (see Figure 1-6).

1.2.4.4 SXblue II, SXblue III and SXblue Platinum with GNSS Survey Antenna

This configuration required two cables linked together with BNC (male + female) connector (see figure 1-7). The GNSS Survey antenna uses termination cable with TNC (male) connector whereas SXblue receiver uses termination cable with SMAR (male) right angle connector (see Figure 1-7).

1.3 Getting Ready for the Field

The SXblue receiver is one component of a modular system that normally includes two other parts: a computer and data collection software. A modular approach has huge advantages:

- Allows the use of any device, tablet PC, laptop or computer technology to suit the application
- Allows the use of any off-the-shelf software
- Allows for keeping up-to-date with the very fast evolving computer/software technology
- Allows greater flexibility/versatility for installation in all sorts of applications.

This section covers the normal steps that one would normally follow to get the system up and running for a generic GIS sub-meter data collection session: knowing the factory default settings of the communication ports and output messages, setting up a Bluetooth connection with a device or computer, installing the USB drivers on a computer, configuring the data collection software for proper operation with the SXblue receiver.

Chapters 2 and 3 present advanced features and configurations of the SXblue receiver for other types of applications: high output rates, carrier-phase post-processing, base station and rover configuration for RTK centimeter-level accuracies, etc.

1.3.1 Default Parameters

Although specified in the following chapters, this section provides tables that detail the default parameters of the SXblue receiver as delivered.

Table 1-1 Default Applications and Performances

SXblue 12/24 volts SXblue II and III series	SXblue Platinum and Platinum AG	SXblue II-B GPS
WAAS (SBAS) <ul style="list-style-type: none"> - <i>Automatic SBAS tracking</i> - <i>RTK Base & Rover optional</i> 	WAAS (SBAS) <ul style="list-style-type: none"> - <i>Automatic SBAS tracking</i> - <i>RTK Base & Rover optional</i> - <i>L-Band (Requires Atlas® Subscription)</i> 	WAAS (Beacon Input) <ul style="list-style-type: none"> - <i>Automatic RadioBeacon tracking</i>

Different applications can be installed on any of the two application memory locations of the SXblue internal memory. The basic application installed on all models is called MFA (Multi-Function Application). Your device may include MFA software that allows you to set the positioning (mode) hierarchy of your device. MFA will search for the best source of differential correction available. The hierarchy is the path your device follows to determine what differential correction to use depending on available sources. The hierarchy is as follows:

1. RTK
2. L-band (Atlas)

3. SBAS
4. Beacon
5. External RTCM
6. Autonomous

If you are using RTK solution and you lose your RTK radio link, the device defaults to the next highest mode, being either Atlas high precision service or SBAS (if available). If the new signal becomes unusable, the next mode will be selected (for example Beacon or External RTCM). Finally, if no correction signals are available, the device defaults to Autonomous.

Table 1-2 Default Port Settings

Port	Baud Rate	Data Bits	Parity	Stop Bit	Interface Level
Bluetooth	115200/ 230400	8	None	1	Serial Port Profile
Serial	19200	8	None	1	RS-232C
USB	19200	8	None	1	Serial Port Emulation

The Bluetooth port is fixed and should not be changed.

- GNSS models: Bluetooth baud rate is 230400.
- GPS models: Bluetooth baud rate is 115200.

When setting up COM port parameters in a software that will communicate via Bluetooth to the SXblue receiver, any baud rate can be specified, but in order to avoid communication overflow, care must be taken in properly selecting the number of sentences output on a port at a particular baud rate. The Serial and USB ports can be configured from 2400 to 115200 baud.

Table 1-3 Default GPS NMEA Message Output

Port	GPS NMEA Messages	Update Rate
Bluetooth	GGA, GSA, GST, GSV, VTG, RMC, RRE, ZDA	1 Hz
Serial	GGA, GST, GSV	1 Hz
USB	GGA, GSA, GST, GSV, VTG, RMC, RRE, ZDA	1 Hz

The SXblue receiver outputs eight (8) standard NMEA messages by default: GGA, GSA, GST, GSV, VTG, RMC, RRE and ZDA. All ports are fully independent from

one to another and can be set to input or output different messages at different rates (NMEA, Binary, Differential correction). Minimum sentences are activated by default on the Serial port, as it is often used with radios for Base/Rover RTK operations, this port can be set for specific use. Refer to Technical Reference Manual for more details on NMEA messages.

Table 1-4 Default Parameters

Max DGPS Age	From 3D to 2D	Elevation Mask	Modes	SBAS Tracking	Decimal
3600 seconds	When PDOP > 10.5	10°	SBASR, Mixed, Forest, Base, Fixloc, Glofix, Suretrack	Automatic	7 decimal digits

Because of the unique technology used on-board the SXblue receiver, the maximum DGPS age can be set to 3600 seconds. Once the SXblue receiver loses its differential correction source, the output will remain sub meter for the next 30-40 minutes. See chapter 2 for more information. For RTK operation, the receiver will maintain a fixed solution for 60 seconds after losing the RTK source; then it will “float” for an extra 2 minutes and finally will default to the next available source of differential correction available (L-Band, SBAS, None, etc). SXblue Platinum will keep longer RTK solution (5 minutes) using special aRTK and Tracer technology.

The receiver is set to switch from 3D mode to 2D mode when there are less than 4 satellites or when the PDOP value exceeds 10.5. It is usually up to the user software to allow or restrict 2D mode operation, but this setting can be changed on the receiver (see Technical Reference Manual).

The satellite elevation mask is set to 10 degrees by default. All satellites below this value will not be used in the solution.

For the various Modes listed in the table, please refer to the Technical Reference Manual.

SBAS tracking is set to Automatic and the number of decimal digits used (in the coordinates of the GGA sentence for example) is set to 7.

1.3.2 Configuring Bluetooth Communication

There are many Bluetooth drivers available on the market today for Pocket PC, Smartphone, Tablet, Laptop, and also for regular computers with standard Microsoft Windows operating systems, Windows Mobile, Android or iOS.

Even though the setup procedure will be different for each of them, the basics remain the same. The two major steps are: discovering a Bluetooth device and assigning a communication port number to the discovered device. The data collection software will then call the assigned port number to receive the data from the SXblue receiver.

In this section, we will give some examples of setting up Bluetooth communication with various computer and device. One key element to remember is that the SXblue receiver does not require any password (often called pairing, secure connection, authentication, passkey, passcode, etc). This feature must be disabled in the options of the driver you are using.

Note – The SXblue does not require any password/passkey for secure connection. This feature must be disabled in the driver configuration of your Computer or device.

A passkey of “12345678” has been programmed in the receivers in case a Bluetooth driver absolutely requires a secure connection.

1.3.2.1 Android OS

Android version 5.1 has been used for this Bluetooth connection procedure. Steps are similar with other version of Android OS. The following screenshots show how to properly handle the configuration steps to connect SXblue receiver with your device.

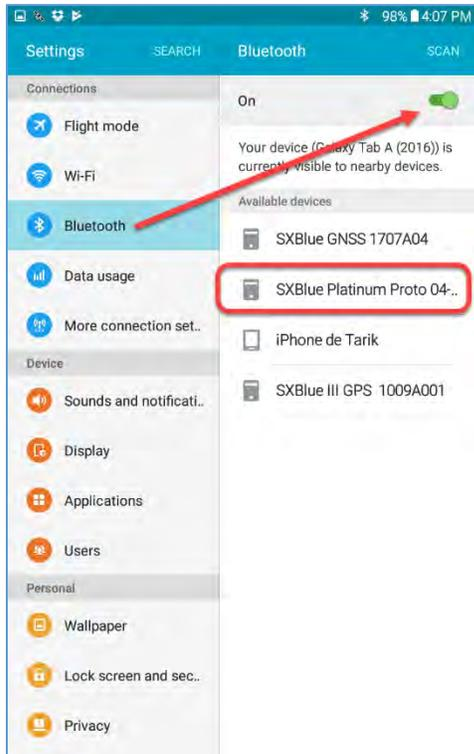

Before running a location application (software), the **SXBlue** receiver must be connected with your Android device using Bluetooth. Once the **SXBlue** receiver has been turned **ON**... Go to the setting icons on the Android device and then select the Bluetooth tab. The Bluetooth switch must be in the **ON** position to discover any Bluetooth devices.

After a few seconds, you will see a device name (eg. **SXBlue Platinum-XXXXXXXX**) icon appear with the same serial number of your receiver. See **Available devices** on the first illustration.

Tap on the **SXBlue Platinum-XXXXXXXX** device to establish the connection: See **Paired devices** on the second illustration.

Once the device is connected. You may verify the **Developer options** under **Settings**. Make sure **Allow mock locations** switch is turned **ON** in order to use external GPS.

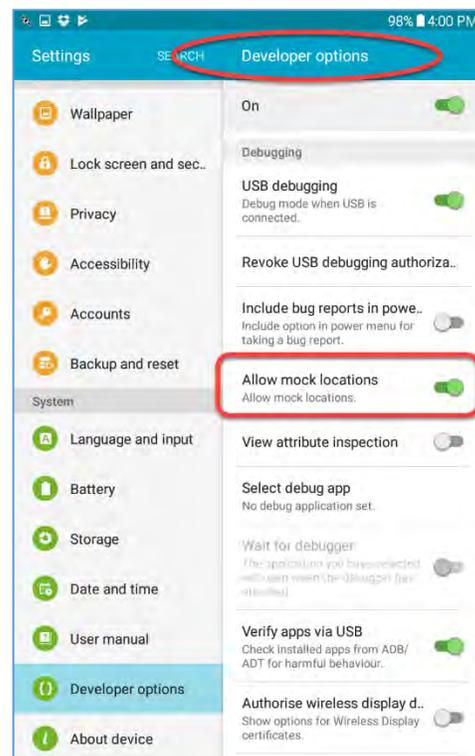
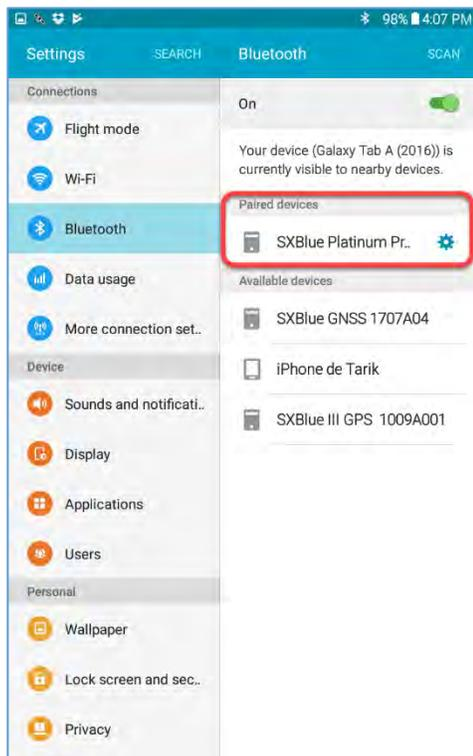

The SXBlue Platinum is now ready to use with your Android application!

1.3.2.2 Apple iOS

iOS version 10.3 has been used for this Bluetooth connection procedure. Steps are similar with other version of iOS. The following screenshots show how to properly handle the configuration steps to connect SXblue receiver with your device.

Before running a location application (software), the SXBlue receiver must be connected with your iPad/iPhone using Bluetooth. Once the SXBlue receiver has been turned ON... Go to the setting icons on the iPad/iPhone and then select the Bluetooth tab. The iPad/iPhone Bluetooth switch must be in the **ON** position to discover any Bluetooth devices.

After a few seconds, you will see a device name (eg. **SXBlue Platinum-XXXXXXXX**) icon appear with the same serial number of your receiver. See **DEVICES** on the first illustration.

Tap on the **SXBlue Platinum-XXXXXXXX** device to establish the connection: see **MY DEVICES** on the second illustration.

Once the device is connected. You may verify the manufacturer settings at **Settings**→**General**→**About**→**SXBlue GNSS Receiver**



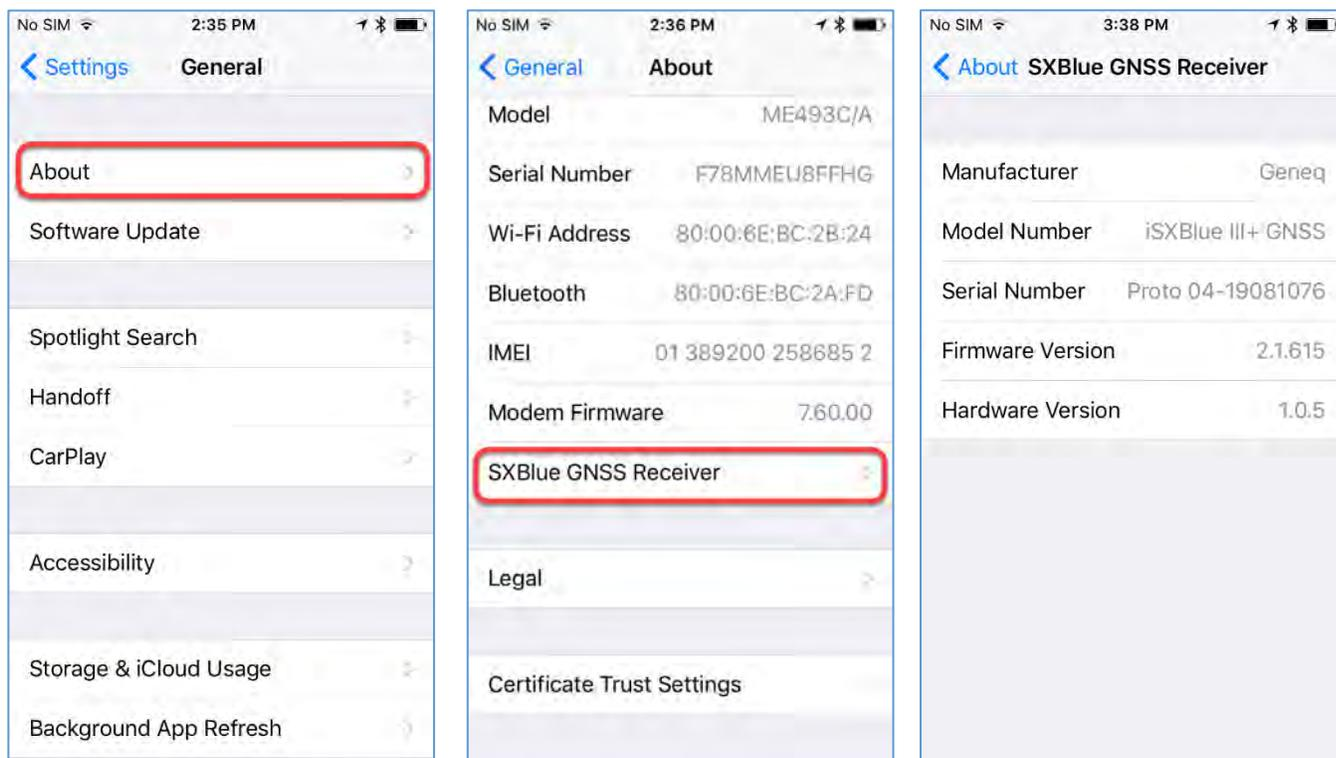

The SXBlue Platinum is now ready to use with your iOS device!

1.3.2.3 Windows 10

Microsoft Bluetooth drivers for Windows 7, 8 and 10 are similar with just a few minor differences. For more details about Windows 7 and 8, please contact SXblue Support on our web site. The following screenshots show how to properly handle the configuration steps to connect SXblue receiver with tablet PC or laptop.

Before running a location application (or survey software), pair the **SXblue** receiver with your Windows 10 computer using Bluetooth. There are two steps to perform this pairing: discovering a Bluetooth device and assigning a communication port number to the discovered device. The data collection software will then call the assigned port number to receive the data from the **SXblue** receiver.

Ensure **Bluetooth** switch is turned **ON** under Bluetooth settings.

From the Start menu of Windows 10, go to **Windows settings**, and select **Devices (Bluetooth, ...)**

From the left panel, select **Bluetooth**. Select the **SXblue** receiver, and tap **Pair** to establish the connection. If a code is required for your **SXblue** receiver, enter the passcode 12345678.

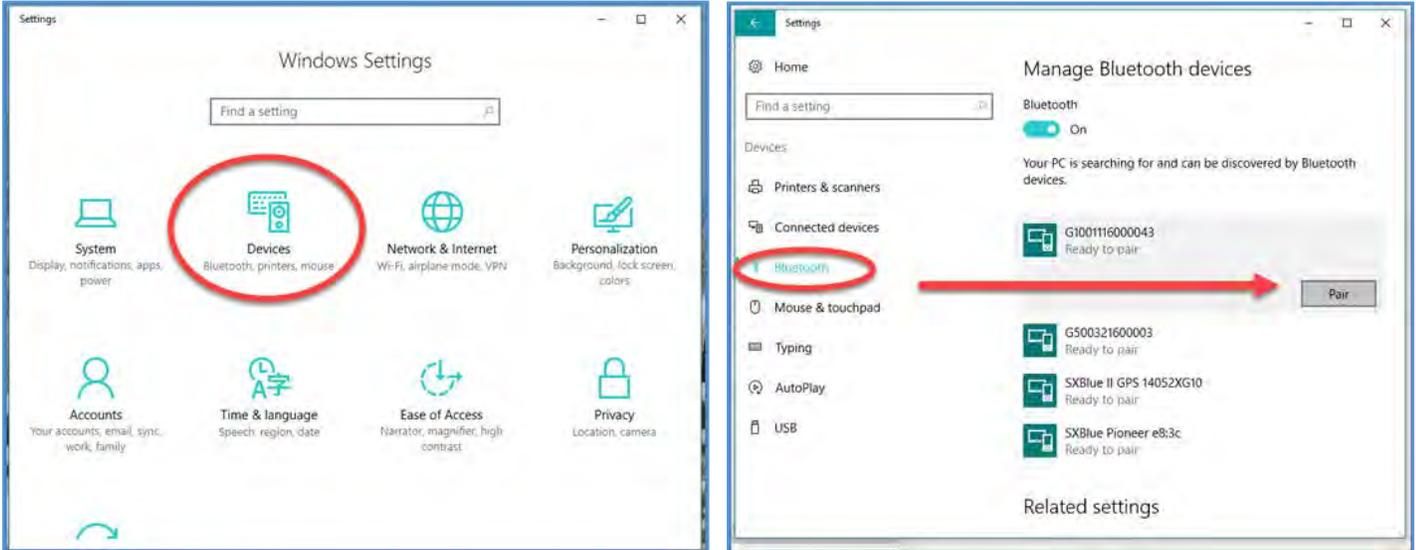

On the bottom of the screen, press **More Bluetooth Options**

Form Bluetooth Settings screen, select **COM Ports** tab, select the **COMxx Outgoing** direction, and press **Add...** button

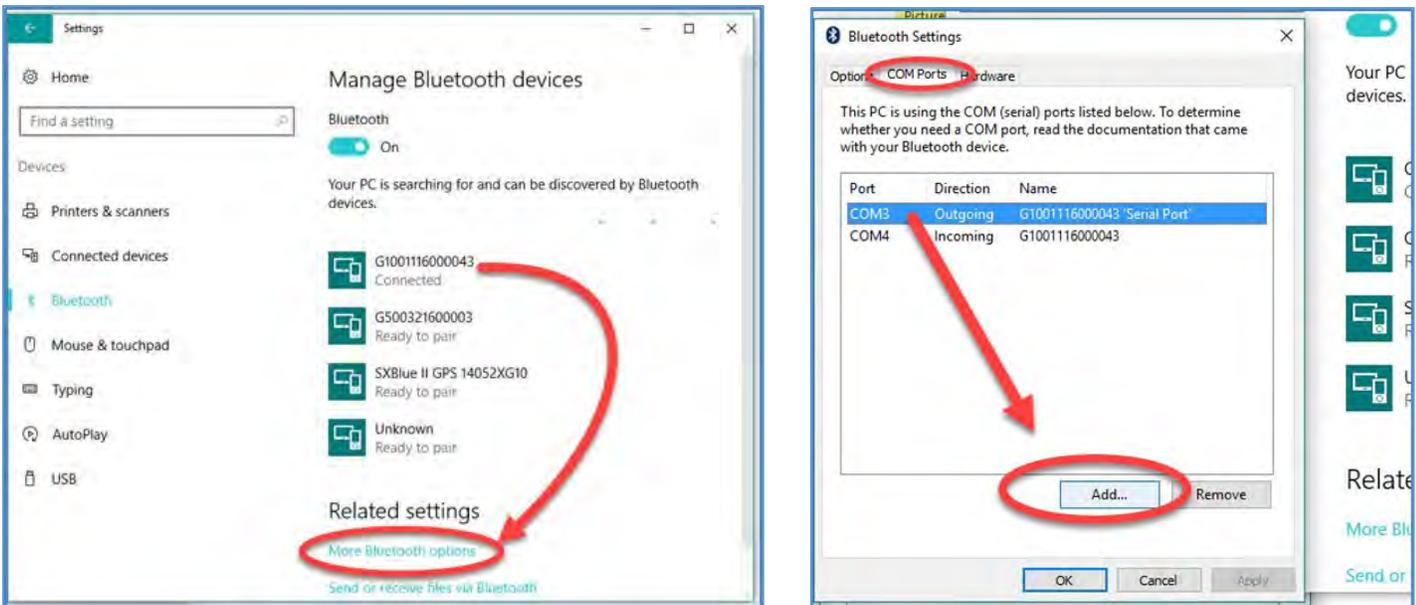

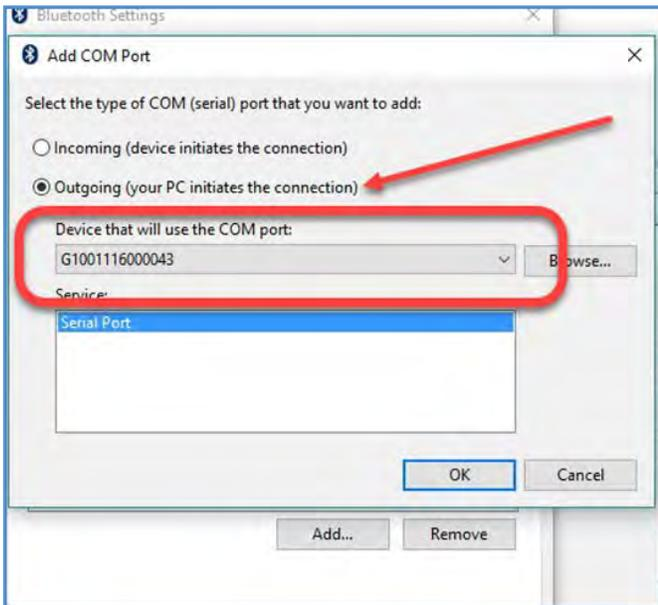

Select **Outgoing** (your PC initiates the connection).

From the scroll down list (Device that will use the COM port:), select the **SXblue** receiver and press **OK**.

Finally, press **OK** again on the bottom of the Bluetooth Settings screen.

From your data collection software settings, you should use the port number that you select on the previous step.

Try to connect with Baud Rate 115200
The SXblue receiver is now ready to use with your computer!

1.3.2.4 Windows Mobile CE

Microsoft Bluetooth drivers for Windows Mobile 5.0, 6.0 and 6.5 are similar with just a few minor differences. The following screenshots show how to properly handle the configuration steps to connect **SXblue** receiver with Pocket PC or field computer.

Before running a location application (or survey software), pair the **SXblue** receiver with your Windows Mobile device using Bluetooth. There are two steps to perform this pairing: discovering a Bluetooth device and assigning a communication port number to the discovered device. The data collection software will then call the assigned port number to receive the data from the **SXblue** receiver.

Ensure **Bluetooth** switch is turned **ON** under Wireless Manager.

From the Start menu, go to **Settings**, and tap the **Bluetooth** icon.

Then tap **Add new device...** under **Devices** tab.

Once the **SXblue** receiver has been found, select it then tap **Next**.

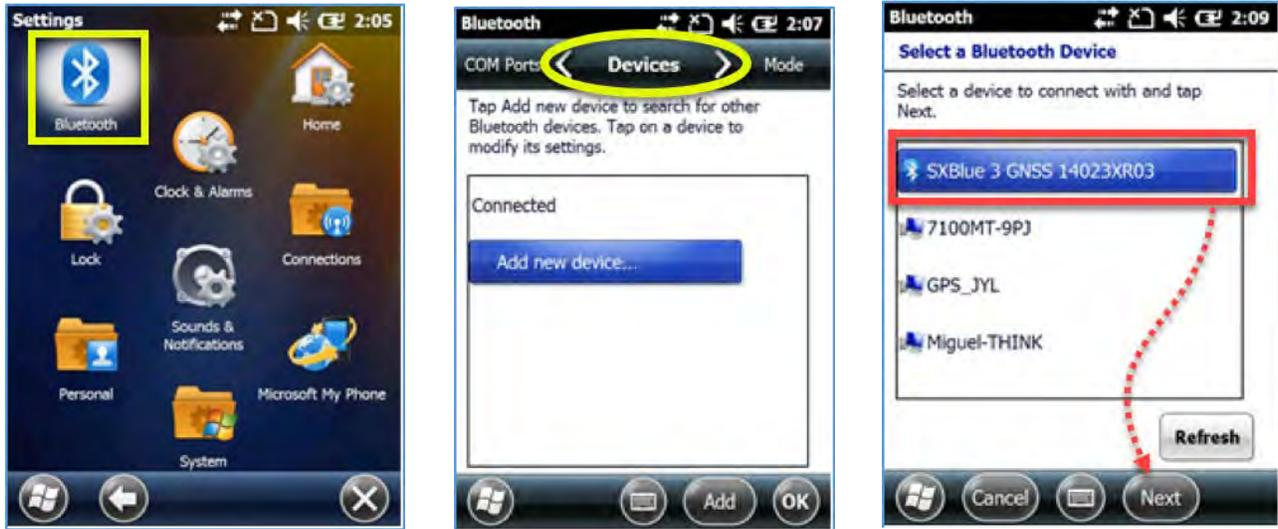

The driver will ask for a Passcode; at this point enter **12345678** and hit **Next**.

Select **Advanced** button in the lower right section of the screen.

Check the **Serial Port** option and tap **Save**. The **SXblue** receiver will be added to the list of discovered devices.

Select **COM Ports** tab then tap **New Outgoing Port**



Select the **SXblue** receiver in the list and hit **Next**.

Unselect the **Secure Connection** option and select a **COM Port number** (in this example: COM 9). It is recommended that you start with the highest COM port number available.

Press **Finish** button.

Your **SXblue** receiver will be shown in the list along with its assigned **COM port number**. This is the port number that should be selected in your data collection software settings.

Press **OK** button.

The **SXblue** receiver is now ready to use with your device!



1.3.3 Installing the USB Drivers for Microsoft Windows

Drivers for SXblue receiver are available for multiple operating systems: Microsoft Windows 98, ME, 2000, 32-bit and 64-bit Server/XP/Vista/Windows 7 and 8. Other drivers are also available for Windows Mobile, Linux, and Mac OS. Windows 10 doesn't required USB driver installation since it can detect automatically if driver update is needed.

There are two versions of the USB drivers for Microsoft Windows: a 32-bit and a 64-bit. Make sure the correct version is used with your operating system.

Once the driver is installed, **the port number assigned to a specific USB port will be the same every time the SXblue receiver is connected to this port.**

The installation software can be found in the "Download" section of the <http://www.sxbluegps.com> web site. The software will install two subsets of the driver: The Serial Converter and the USB Serial Port emulation.



In the ***SXblue – USB Driver Setup***, the default location for the driver installation will be “C:\Program Files\SXblue GPS\SXblueIIGPS USB Drivers”. Click on ***Install***. The driver files will be uncompressed to the specified location and the ***Installer*** window will be displayed. Click on ***Next*** to proceed with the installation.

Once the installation is completed, the ***Installer*** window will display the name of the two driver subsets.



In order to find the COM port number that Windows has assigned to the SXblue, the receiver must be connected to the USB port and powered on.

From Windows, go to ***Start***, select ***Settings*** and then ***System***.

From the left panel of ***System*** screen, select ***About***, then on the right portion of the screen, tap on the ***Device Manager***.

Scroll down to and expand the ***Ports (COM & LPT)*** category. The ***SXblue – USB Serial Port*** will be shown with the COM port number assigned to it.

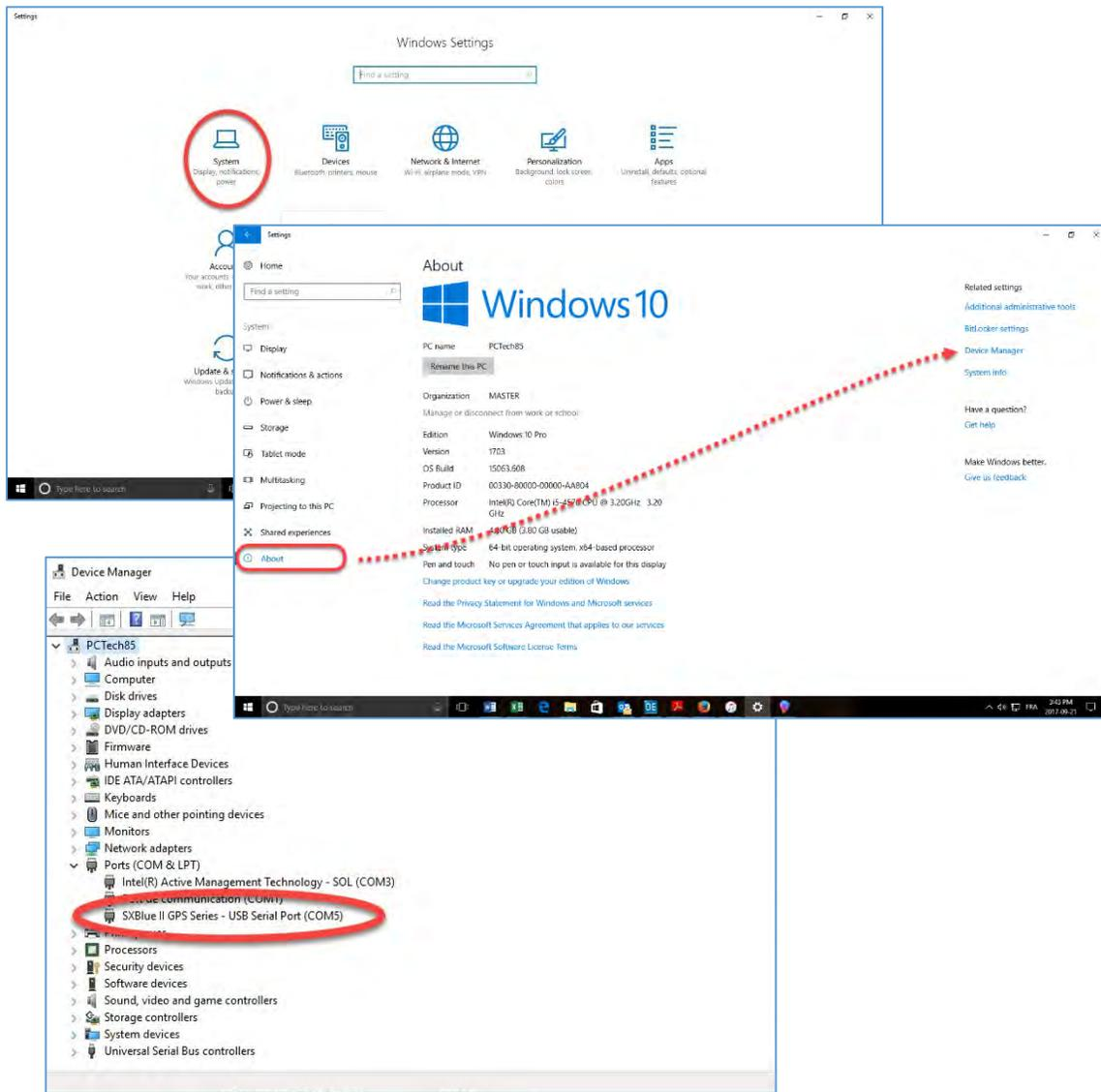

1.4 In the Field

This section covers the following topics: setting up SXblue receiver for sub meter work using the nylon carrying case and soft hat, setting up the receiver on a range pole using optional accessories such as mounting plate and brackets, definition of the LED indicators, generic data collection software configuration and basic recommendations for optimal performance. The antenna mounting plate is optional and must be used in a backpack or survey range pole setup. Some support and brackets or optional but recommended to fix the SXblue receiver and the SXpad data collector on a range pole.

1.4.1 Setting up for Sub meter Work

For applications requiring only sub meter positioning, a soft hat for the Precision Antenna is provided when you order the Standard Package. Proper installation of the receiver and cable in the carrying case is shown in the subsection below.

1.4.1.1 Using the Nylon Carrying Case

The supplied nylon carrying case features a belt loop and can also be used with a belt clip or a shoulder strap. The pictures below show how to properly run the antenna cable in the carrying case.



Figure 1-8 Carrying Case

1.4.1.2 Using the Soft hat

When using the soft hat or the antenna mounting plate, the magnet adaptor should be removed from the Precision Antenna. Simply locate the four screws at the

bottom of the antenna and use a “Philips” type screwdriver to remove the magnet adaptor (see Figure 1-9).

Insert the Precision Antenna in the pouch on top of the soft hat, close the flap while allowing the antenna SMA connector to pass through the hole and attach the cable by tightening the SMA connector all the way (see Figure 1-10).



Figure 1-9 Removing the Magnet Adaptor



Figure 1-10 Using the Soft hat

1.4.2 Setting up for RTK Work

For applications requiring more accuracy, the SXblue receiver and its antenna will be normally mounted on a survey range pole. The Survey Antenna requires no extra setup but the Precision Antenna must be mounted on the optional Antenna Mounting Plate (see Figure 1-11). Both the Survey and the Precision Antenna Mounting plate feature a 5/8 inches standard survey pole fitting. SXblue receiver requires optional L-shaped bracket and Pole clamp to setup on a range pole. Finally, a mounting bracket (support) can be paired with a mechanism to the clamp for the SXPad data collector.

1.4.2.1 Using the Precision Antenna Mounting Plate

Follow the steps in the previous subsection to remove the magnet adaptor from the Precision Antenna. Firmly attach the right-angle SMA/SMA adaptor to the antenna with the tip of the connector pointing down (see Figure 1-11). Do not overtighten.



Figure 1-11 Using the Antenna Mounting Plate

Install the antenna on the mounting plate so that the SMA connector is perfectly aligned with the slot and the screw holes match one set of the patterns at the bottom of the plate (see Figure 1-11).

Use the screws provided with the mounting plate to secure the antenna.

Attach the cable to the antenna making sure the SMA adaptor remains tight.

1.4.2.2 Range pole Setup

This section shows how to mount the SXblue receiver on a range pole using the carrying case and the optional L-shaped bracket.

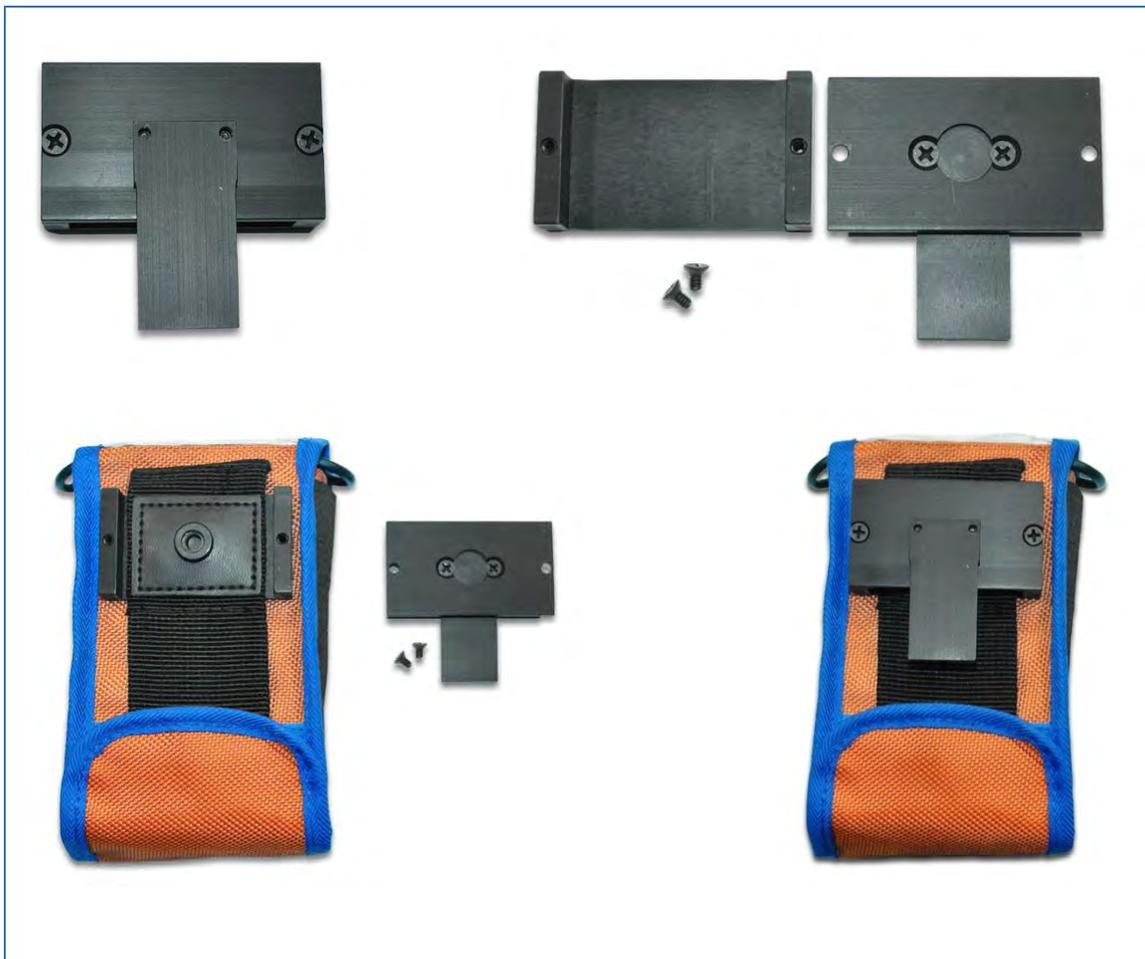

Figure 1-12 Using the L-Shaped Bracket

Separate the two parts of the L-Shaped Bracket by removing the two outer screws in the back (see Figure 1-12).

Slide the “U” shaped part of the bracket through the belt-loop of the nylon carrying case.

Place the cover back (with the two inner screws facing inside) and tighten the two outer screws.



Figure 1-13 Mounting on a Range pole

Attach the Pole clamp on the range pole and simply slide the SXblue receiver's L-Shaped bracket into the Pole Clamp slot (see Figure 1-13).

The Pole clamp and L-Shaped bracket are only supplied with the SXblue Platinum Survey Kit package. SXblue receiver can be fixed on the range pole without using nylon carrying case by fixing L-Shaped bracket directly on the back of the battery with two screw. A mounting bracket (support) can be paired with a mechanism to the clamp for the SXPad data collector (shown in the above illustration).

1.4.3 Antenna Phase Center

The following diagrams show the phase centers for the various types of antenna supplied with the SXblue Series. If only one phase center measurement is required by the RTK or post-processing software, the L1 phase center must be used. The mounting plate height should also be added to range pole height. Measurements are in mm (inches).

1.4.3.1 GNSS Precision Antenna

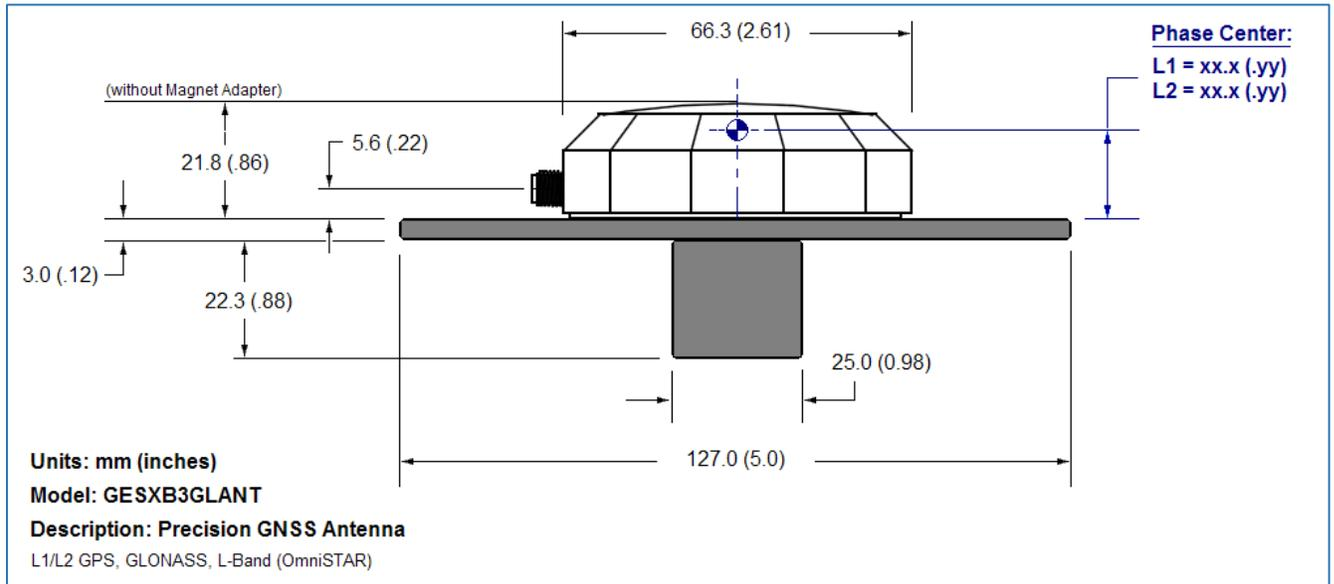

Figure 1-14 Phase Center – Precision GNSS Antenna (GESXB3GLANT)

1.4.3.2 GNSS Survey Antenna

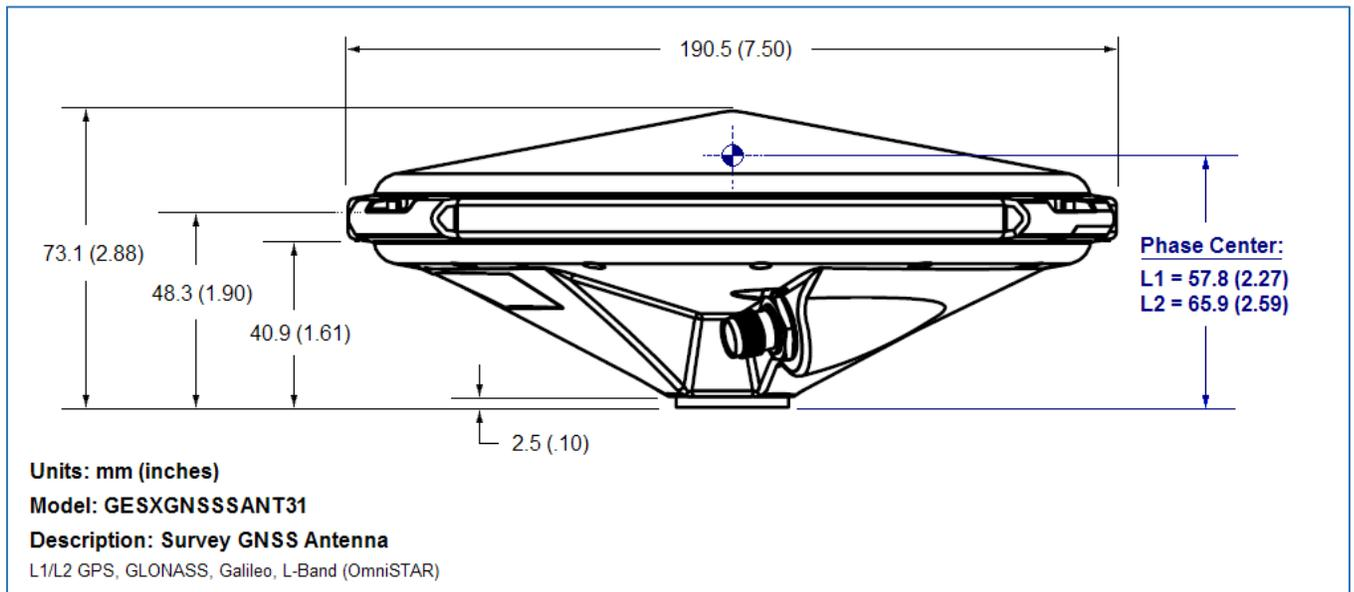

Figure 1-15 Phase Center – Survey GNSS Antenna (GESXGNSSANT31)

1.4.4 Definition of the LED Indicators

The SXblue receiver features diagnostic LEDs that provide a quick indication of the receiver's status. These LEDs are visible on the front panel display (see Figure 1-16).



Figure 1-16 SXblue Series Front Panel

The five diagnostic LEDs visible on the front panel display of the SXblue provide the following information:

Table 1-5 LED Indicators Definitions

LED	Color	Function
	Red	Power – when the SXblue receiver is powered, this LED will illuminate. When battery is low, the Power indicator will start blinking 20 minutes prior to auto shut-down.
	Green	GPS Lock – once the SXblue receiver achieves a solid GPS lock and computing a valid position, this LED will remain illuminated. If this LED continues to blink, it could be an indication of a receiver hardware failure.
	Orange	<p>DGPS Position – this LED will illuminate when the receiver has achieved a differential position and the pseudorange residuals are below that set with the \$JLIMIT command and the computed solution is a 3D fix. The default value is a pseudorange residual of better than 10 meters. If the residual value is worse than the current threshold, the orange DGPS LED will blink indicating that differential mode has been attained but that the residual has not yet met the threshold. The same happens when the PDOP exceeds the 10.5 factory default threshold and switches to 2D mode (this is set with \$JALT, sometimes, 10.5).</p> <p>For DGPS operation, the LED will blink to an amount of time equivalent to the \$JAGE value (default is 3600 seconds) if the source of differential correction (ex. SBAS) is lost. The Coast technology will maintain sub meter accuracy for 30-40 minutes depending on ionospheric conditions.</p> <p>For RTK operation under the MFA application, it will remain solid for 1 minute after the loss of RTK signal and blink for an extra 2 minutes indicating a float solution; after a total of 3 minutes the receiver will switch to the next best available differential correction source (ex. SBAS if available).</p>
	Yellow	Differential Lock – this indicator will illuminate continuously when the SXblue receiver has achieved a solid SBAS or Atlas lock (depending on model) with better than a 150 bit error rate (BER) or when it is successfully receiving externally input RTCM/RTK corrections. For example, if the SBAS BER is higher than 150 but the receiver is still locked, this LED will blink, showing that lock is marginal.
	Blue	Bluetooth – this LED will illuminate when there is a Bluetooth connection between the SXblue receiver and a Bluetooth compatible device and blinking, depending when there is no Bluetooth connection.

Note: When the SXblue receiver acquires a GPS lock, the green GPS lock LED will illuminate. Similarly, the yellow differential LED (DIFF) will illuminate when differential corrections are being received successfully. The orange DGPS LED will illuminate when the receiver has acquired a GPS lock, differential lock, and has applied corrections within the position solution. The following image displays the front panel layout of the SXblue receiver, including the location and labelling of each LED. For more information on LED operation and troubleshooting, refer to Technical Reference Manual.

1.4.5 GIS Field Data Collection and Datum Considerations

For optimal performance and results of field data collection, proper configuration of the field software and some common GPS guidelines are essential when using the SXblue receiver. This section only lists some important points to be aware of before going to the field but Chapter 3 - Advanced Operations, will cover the required receiver configurations in detail.

1.4.5.1 Generic Field Data Collection Software Configuration

The software that will be used for collecting GPS data should accept **standard NMEA messages**. As mentioned in section 1.3.1, the SXblue receiver output by default eight (8) NMEA sentences: GGA, GSA, GST, GSV, VTG, RMC, RRE and ZDA all at 1Hz (once every second) on the Bluetooth and USB ports. Minimum sentences are activated by default on the Serial port, as it is often used with radios for Base/Rover RTK operations, this port can be set for specific use. Refer to Technical Reference Manual for more details on NMEA messages.

- To communicate with the SXblue receiver via its Serial or USB port, a **baud rate of 19200** must be set in the communicating software. To set the baud rate to higher values on these two ports, refer to Technical Reference Manual for sending commands to the SXblue receiver.
- The coordinates output by the SXblue receiver follow the differential correction source datum. You should make sure that your data collection software is up-to-date, supports and applies the proper transforms to GPS data it receives to match your existing map data.
 - When not using differential correction, the output coordinates from the SXblue receiver are in the **current GPS WGS84 (G1674) datum** (note that there have been many evolutions of the WGS84 datum over the years and the current revision differs greatly from the original one).
 - When using SBAS, the coordinates will be in ITRF 2008 current epoch.
 - When using the SXblue Platinum with an Atlas subscription, the datum will be in ITRF 2008 (epoch 2010) worldwide.
 - When using RTK corrections, the datum will depend on the reference frame of the local RTK network, or if using a base/rover configuration, the output coordinates will follow the same datum of the base station coordinates.

Masks and filters are very useful features of field data collection software and prevent recording of poor GPS data. HDOP or PDOP limits should be set to proper values to suit the application (accuracy vs. productivity). A “3D only” mode is useful for optimal accuracy but an “Allow 2D Mode” can be very convenient in some forestry applications. If a “DGPS Only” or an “RTK Only” mode is available, we strongly suggest that it be used. Also for RTK operations a mask on the RMS value (found in the standard GST NMEA sentence) offers great benefits. For optimal performance and results of field data collection, proper configuration of the field software and some common GPS guidelines are essential when using the SXblue series.

1.4.5.2 General Guidelines for Sub meter GIS Field Data Collection

- **Proper antenna location** is critical for sub-meter positioning. The best location for a GPS antenna is above the head with no obstruction of the sky. A soft hat for the precision antenna is supplied with the SXblue receiver standard packages. In the case where the use of a security hardhat is a must, the antenna can be mounted inside or outside the hat with Velcro type material. For applications requiring a survey or backpack range pole, refer to the previous subsections for mounting the Precision Antenna and the receiver on a range pole. When less accuracy is needed, the antenna can be shoulder-mounted (ex. on a cruising vest for some forestry work).
- When the SXblue is first powered in a data collection session, it is preferable to allow it to **track GPS and SBAS satellites for a minimum of 5 minutes** (ideally 10 minutes) before recording any data. Here are a few reasons for doing this:
 - A GPS receiver, with a freshly downloaded GPS almanac, will track better under obstructed conditions like in forestry applications
 - It can take up to 5 minutes for a GPS receiver to download a complete Ionospheric Grid from an SBAS satellite. A special feature of the SXblue Series is its ability to extrapolate the downloaded grid (see chapter 2)
 - With the GNSS models, SureTrack technologies enable the use of GLONASS satellites in the code DGPS and phase RTK solution respectively, without receiving GLONASS corrections from the differential source (SBAS, RTK, GPS-only base station, etc). This unique feature requires 3 to 5 minutes of tracking constant GPS differential corrections signal.
 - For forestry applications, if SBAS visibility is marginal, it is preferable to activate the receiver outside of forest canopy condition, let the receiver track the SBAS signal for at least 5 minutes, then the data collection can start
 - It takes about 2 minutes of GPS tracking for carrier phase smoothing to be effective
 - If doing sub meter work, it is preferable to let the receiver settle (for about 15 to 30 seconds) after a loss of position fix, prior to resume data collection.

1.4.5.3 Basic Knowledge for RTK Field Work

- When used in RTK applications, the **Precision Antenna** supplied with the Standard package will provide with reliable cm accuracy but might present some limitations. For base/rover configuration (rover receiving corrections via radios or IP connection from a reference station, called a single baseline solution) it is preferable to remain within 15 km of the reference station. As the baseline increases, it might take a bit longer to fix the ambiguities of the carrier phase. For typical surveying work and/or longer baseline length the

GNSS Survey Antenna (supplied with the Survey package, but purchasable separately) is recommended primarily because of the larger ground plane and sensibility it offers.

- In order to connect to an RTK network a utility called DIP/NTRIP client must be used. Some surveying software already feature a built-in NTRIP client, but many on the market do not. SXblue GPS offers, free of charge, a stand-alone **NTRIP client** called the **SXblue RTN** to allow such software to benefit from RTK corrections. The SXblue RTN will generate virtual COM ports on the PC or Windows Mobile device to allow only on single Bluetooth connection to the SXblue receiver. There are three types of Internet reference network available:
 - **DIP (Direct IP)** where the rover connects directly to a single reference station via a TCP/IP and gets corrections from this particular reference station. In this case, an IP address and a port number are specified.
 - **NTRIP (Networked Transport of RTCM via Internet Protocol)** protocol with no VRS computations is similar to the previous one, with the following differences: a username and password is required and automatically downloaded list (or table) presents all mountpoints (particular solution and data type) available in the network. Once a mountpoint is selected the corrections are received.
 - **NTRIP with Virtual corrections.** This similar to the last one with the addition that a virtual correction is computed specific to each user (rover) location, thus eliminating the need to be “close” to a particular reference station. One requirement is that the rover must send its position to the network at regular intervals (usually 5 to 10 seconds) using the standard NMEA GPGGA string. The NTRIP client automatically handles this part.
- SXblue GNSS multi-frequency model, receiving GPS and GLONASS corrections from a reference station will show a faster and more robust ambiguity resolution because of the increased number of observables (satellites). If the reference station is not broadcasting GLONASS corrections then the unique **SureTrack** Technology, after a couple of minutes of receiving GPS-only corrections, will internally generate corrections for the GLONASS satellites and the SXblue receiver will thus use all satellites in view. This feature will greatly help in challenging conditions when compared to a GPS-only fixed solution.
- It is also worth mentioning that a much faster ambiguity resolution will be achieved when the **age of the differential corrections** received from the reference station does not exceed 1 or 2 seconds.
- **RTK operations under tree canopy are not suitable.** If you choose to attempt this, we recommend you take repeat measurements on the same

point at different time of the day to confirm the reliability of the position. In urban canyon environments (tall buildings nearby), performance will depend on the number of satellites in view and the effects of multi-path, if any. Watching (or setting masks in your software for) the differential status of the receiver (Fixed, Float, DGPS, GPS) and the RMS value are of great importance when the highest possible level of accuracy is required from the SXblue receiver. If using RTK corrections (RTCM 3.x for example) in a forested environment, and not requiring the highest accuracy, the receiver will perform better if it is prevented from trying to go into fixed integer (RTK) mode. See the \$JRTK,12 command in the Technical Reference Manual for more information.

- To avoid errors in the software-displayed elevations, it is important to add the phase center information provided in section 1.4.3 of this manual to the overall measured height of the range pole (and antenna mounting plate if using one of the Precision Antenna).

1.4.5.4 What to Know About Atlas Services (SXblue Platinum only)

- Atlas Services overview and operations are covered in the following two chapters, but some important facts are presented in this section. **Atlas offers three (3) levels of satellite differential correction Scalable services** that require a subscription with the company:
 - **Atlas Basic: 50 cm 95% (30 cm RMS)**
 - **H30: 30 cm 95% (15 cm RMS)**
 - **H10: 8 cm 95% (4 cm RMS)**
- **Atlas** is a multi-frequency, multi constellation **Global Correction Services for GNSS**. Atlas support is being introduced across a wide range of multi-frequency, RTK-capable hardware, available worldwide.
- Atlas is delivering its correction signals via L-Band satellites or IP address at accuracies ranging from meter to sub-decimeter levels. With approximately 200 reference stations worldwide and L-Band satellites distributing coverage from 75°N to 75°S, all of the earth's landmass is covered.
- Positioning Sustainability: Cutting-edge position quality maintenance in the absence of correction signals.
- Convergence Time: Industry-leading convergence times of 10 – 40 minutes.

1.4.6 Available Software and Utilities

This section gives a brief overview of the various software and utilities available for the SXblue receiver. Throughout this manual, various menus of some of the utilities are presented to help configure and monitor the receivers for specific applications.

All software and utilities are free (with the exception of the SXblue Server, the SXblue GPS EZSurv post-processing software, SXblue GPS FielGenius and ESRI Collector) and can be downloaded from the www.sxbluegps.com or www.esri.com web site. The SXblue Server features a trial mode with full functionality but with a limitation of one hour per execution. Please contact your SXblue representative for more information on how to purchase these products.

1.4.6.1 SXblue Config



SXblue Config is a **free utility** to configure and monitor the SXblue receiver. It also allows logging NMEA messages and raw data. Available for Windows 2000/XP/7/8/10 (32-bit and 64-bit) and for Windows Mobile 6.x.

1.4.6.2 SXblue RTN



When your field software does not feature a built-in NTrip and/or DIP client, SXblue RTN is a **free utility** that allows the SXblue receiver to use RTK/DGPS Internet corrections from a network. It uses only one communication port with the SXblue receiver to both send the corrections and receive the NMEA messages. A virtual COM port is created on your computer to allow your software to receive RTK corrected positions. Available for Windows 2000/XP/7/8/10 (32-bit and 64-bit) , for Windows Mobile 6.x, and iOS.

1.4.6.3 SXblue Server

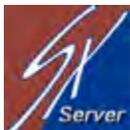

SXblue Server is a TCP Direct IP server with NTrip emulation to set your base station on the Internet. Besides being used as a stand-alone server, it is capable of linking to an NTrip Caster as a mountpoint. It also features a mirror mode to allow a base station to be carried in the field. Available for Windows XP/7/8/10, 32-bit and 64-bit.

1.4.6.4 SXblue Mirror



SXblue Mirror is a **free utility** that allows an SXblue base station to be installed in the field and use the Mirror mode of the SXblue Server to allow a DIP connection from an SXblue rover. As there are many free applications available on the Internet for Windows, this utility was only designed to support Windows Mobile 6.x..

1.4.6.5 RINEX Converter



RINEX Converter is a **free utility** to convert SXblue receivers' raw binary data to standard RINEX format. Data can be collected with the SXblue Config software or any other software capable of recording binary files. Available for Windows 2000/XP/7/8/10 (32-bit and 64-bit) and for Windows Mobile 6.x.

1.4.6.6 SXblue GPS EZSurv



The SXblue GPS EZSurv is the SXblue version of Effigis' post-processing software. This software can be installed on more than one computer but only processes SXblue rovers for which the serial number has been registered. Many upgradable levels are available: L1 Lite, L1 GPS, L1 GNSS, L1/L2 GPS, L1/L2 GNSS. The software processes automatically multiple baselines, with automatic search and download of Internet base stations and also supports PPP (Precise Point Positioning).

1.4.6.7 SXblue GPS FieldGenius



FIELDGenius® The SXblue GPS FieldGenius is the most productive and easy-to-use data collection software solution ever! This software has great graphic user interface, one-screen graphical stakeouts, easily deciphered raw file that you can edit, powerful COGO tools, DXF file support, streamlined connection to your instrument or computer, multi-point resections, roading, training movies, and the easiest, most powerful linework tools in the industry.

1.4.6.8 ESRI Collector



Collect and update information in the field. Take your maps and data offline and sync changes when connected. Improve your data quality with easy-to-use map-driven forms. Track your work and report your activities. Capture and share photos and videos. Work seamlessly with Navigator for ArcGIS, Operations Dashboard for ArcGIS, Survey123 for ArcGIS, and Workforce for ArcGIS. Works on iOS, Android, and Windows 10. Achieve data collection with ensured spatial accuracy for critical assets.

2. Features and Performance

This chapter describes various operation mode and high-level features of your SXblue receiver. The remaining chapters provide more detailed information on the workings of the product.

As mentioned in the previous chapter, if you are new to GPS, SBAS, DGPS, RTK or Atlas® corrections, we recommend that you consult Appendix B for further information on these services and technologies.

When powered for the first time, the SXblue receiver will perform a 'cold start', which involves acquiring the available GPS/GNSS satellites in view and the default differential service.

If you choose to use an external source of RTCM SC-104 correction data, you will need to ensure that the external source supports an eight data bit, no parity, and one stop bit configuration (8-N-1) and a baud rate between 4800 and 230400 baud.

2.1 GPS

The following sections describe the general operation of the SXblue receiver running the MFA (Multi-Function Application firmware).

2.1.1 Satellite Tracking

The SXblue receiver automatically searches for GPS satellites, acquires the signal, and manages the associated navigation information required for positioning and tracking. This is a hands-free mode of operation. Satellite acquisition quality is described as a signal to noise ratio (SNR). A higher SNR is indicative of better quality signal reception. For the GNSS models, GPS-GLONASS-Galileo-BeiDou and QZSS1 satellites can be tracked, and **SureTrack** Technology will internally generate corrections for the GLONASS satellites and the SXblue receiver will thus use all satellites in view to calculate the solution.

Note – The GPS engine is always operating, regardless of the DGPS mode of operation.

2.1.2 Positioning Accuracy

The SXblue receiver is a sub-meter (horizontally), 95% accurate product under ideal conditions (minimum error) when using code-phase, centimeter when using RTK, decimeter/sub-meter when using Atlas services and sub-centimeter when used in post-processing.

Keeping in mind that this horizontal performance specification is a real world but ideal scenario test, obstruction of satellites, multipath signals from reflective objects, and operating with poor corrections will detract from the receiver's ability to provide accurate reliable positions. Sub meter differential performance can also be compromised if the SXblue receiver is using SBAS in a region without sufficient ionospheric map coverage. If external corrections are used, the distance between the remote and reference station antennas can affect performance.

Since the SXblue receiver will be used sometimes in harsh conditions, blockage of the line of sight to SBAS satellites is often inevitable. The COAST technology provides solace from obstruction of SBAS or other code-phase differential correction services for up to about 40 minutes, depending on the amount of tolerable performance drift.

The estimated positioning accuracy is accessible through the use of NMEA 0183 command responses (GST NMEA data message) as described in the Technical Reference Manual. As the receiver is not able to determine accuracy with respect to a known location in real time (this is traditionally performed in post-mission analysis), the accuracy numbers are relative in nature and are approximates.

2.1.3 Update Rates

By default, the SXblue receiver is supplied with a 1 Hz update rate. Higher update rate option can be purchased via your dealer and a code will be used to unlock the feature. Other available update rates are 10 Hz and 20Hz. Carrier phase output is standard on the SXblue receiver.

The update rate of each NMEA and binary message of the SXblue receiver can be set independently with a maximum that is dependent upon the message type. Some messages have a 1 Hz maximum, for example, while others are up to 20 Hz.

Higher update rates are valuable for applications where higher speeds are present (such as aviation, UAVs or racing cars) or more frequent updates are required for manual navigational tasks, such as Agricultural Guidance.

2.2 SBAS

The following sections describe the general operation and performance monitoring of the SBAS demodulator within the SXblue receiver. See Appendix B for more information on SBAS currently (at time of print) available in the world.

2.2.1 Automatic Tracking and Ranging

The SBAS demodulator featured within the SXblue receiver will automatically scan and track the SBAS satellite signals. At time of print, SBAS signals available are WAAS (USA and covering Central and North America), EGNOS (Europe), MSAS (Japan) and GAGAN (India). This automatic tracking allows the user to focus on other aspects of their application rather than ensuring the receiver is tracking SBAS correctly.

The SBAS demodulator features three-channel tracking that provides an enhanced ability to maintain acquisition on a SBAS satellite in regions where more than one satellite is in view. This redundant tracking approach will result in more consistent acquisition of a signal when in an area where signal blockage of either satellite is possible.

Furthermore, the SXblue receiver is set by default with the SBAS ranging feature activated. This feature uses the SBAS satellites in the position computation. In other words, the geosynchronous SBAS satellites, besides providing with the differential correction and when broadcasting ranging information, are also used as “extra” GPS satellites. As an example, WAAS satellites provide with ranging information whereas EGNOS’ do not.

2.2.2 SBAS Performance

The performance of the SBAS receiver is described in terms of a differential LED. SBAS requires a line of sight to the SBAS satellites in order to acquire the signal.

The BER number indicates the number of unsuccessfully decoded symbols in a moving window of 2048 symbols. Due to the use of forward error correction algorithms, one symbol is composed of two bits. The BER value for both SBAS receiver channels is available in the RD1 NMEA data message described in detail in chapter 4.

A lower BER indicates that data is being successfully decoded with fewer errors, providing more consistent throughput. The bit error rate has a default, no-lock value of 500 or more. As the receiver begins to successfully acquire the signal, it will result in a lower bit error rate. For best operation, this value should be less than 150 and ideally less than 20.

Space-Based Augmentation Systems broadcast an ionospheric map on a periodic basis that may take up to 5 minutes to receive upon start-up. The SXblue receiver uses the GPS broadcast ionospheric model until it has downloaded the SBAS map, which can result in lower performance as compared to when the map has been downloaded. This will be the case for any GPS product supporting SBAS services. The SureTrack feature is also dependent on the SBAS ionospheric map and the GLONASS satellites will not be included in the solution before the SBAS map is downloaded.

Caution – When the map has been downloaded, you may observe a position jump due to the potential difference between the GPS ionospheric model and the ionospheric SBAS map. To minimize the impact of this issue on your use of the SXblue receiver, you may wish to wait up to five minutes before using the receiver.

To improve upon the ionospheric map provided by SBAS, the receiver extrapolates information from the broadcast ionospheric coverage map, extending its effective coverage. This allows the receiver to be used successfully in regions that competitive products may not. Please note that the process of estimating ionospheric corrections beyond the WAAS broadcast map would not be as good as having an extended SBAS map in the first place. This difference may lead to minor accuracy degradation.

Figure 2-1 shows sample grids for WAAS, EGNOS, GAGAN and MSAS systems. The inner areas are actual broadcast grids by the satellites and the outer areas are the extrapolation the SXblue receiver achieves. Note that the SBAS grid maps shown are typical as their extents constantly undergo slight changes due to ionospheric activities and time of the day. But overall, the coverage map fairly consistent from one day to another.

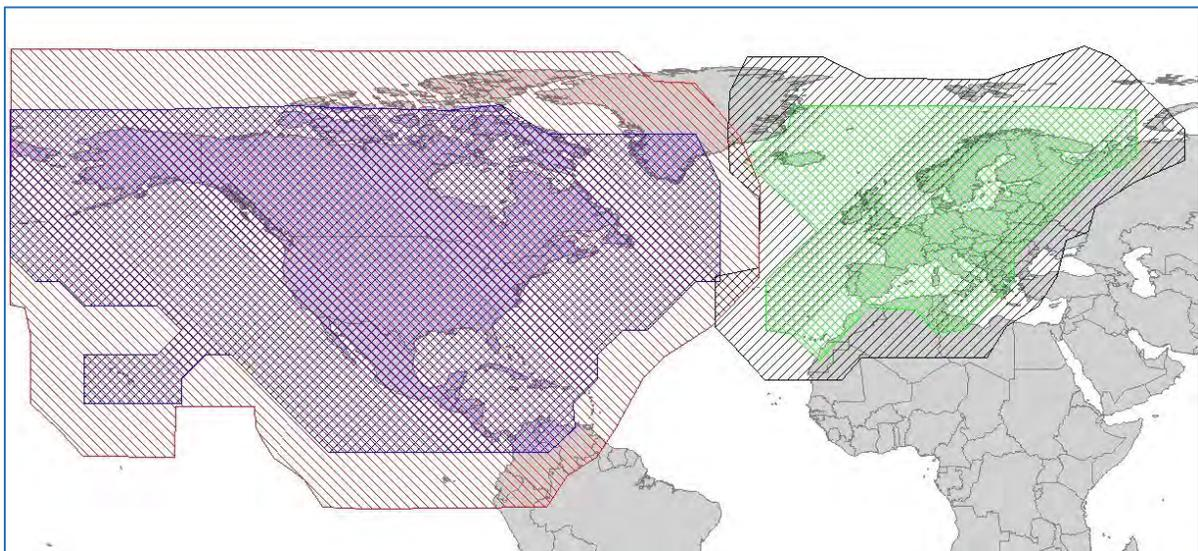

Figure 2-1 Sample Extrapolated Ionospheric Grids

2.3 DGPS RadioBeacon (for SXblue II-B)

Many marine authorities, such as Coast Guards, have installed networks of radio beacons that broadcast DGPS corrections to users of this system. With the increasing utility of these networks for terrestrial applications, there is an increasing trend towards densification of these networks inland.

2.3.1 RadioBeacon Range

The broadcasting range of a 300 kHz beacon is dependent upon a number of factors, including transmission power, free space loss, ionospheric state, surface conductivity, ambient noise, and atmospheric losses.

The strength of a signal decreases with distance from the transmitting station, due in large part to spreading loss. This loss is a result of the signal's power being distributed over an increasing surface area as the signal radiates away from the transmitting antenna.

The expected range of a broadcast also depends upon the conductivity of the surface over which it travels. A signal will propagate further over a surface area with high conductivity than a surface with low conductivity. Lower conductivity surfaces, such as dry, infertile soil, absorb the power of the transmission more than higher conductivity surfaces, such as sea water or arable land.

A radio beacon transmission has three components:

- Direct line of sight wave
- Ground wave
- Sky wave

The line of sight wave is not significant beyond visual range of the transmitting tower and does not have a substantial impact upon signal reception.

2.3.2 Signal Reception

Various sources of noise affect beacon reception and include:

- Engine noise
- Alternator noise
- Noise from power lines
- DC to AC inverting equipment
- Electric devices such as CRT's, electric motors and solenoids

Noise generated by this type of equipment can mask the beacon signal, reducing or impairing reception.

When using the internal beacon receiver as the correction source, selecting an appropriate location for installation of the antenna will influence the performance of the internal beacon receiver. The following list provides some general guidelines for deciding upon an antenna location:

- Choose a location with a clear view of the sky. This is also important for GPS, WAAS, and Atlas signal reception.
- Choose a location that is at least three feet away from all forms of transmitting antennas, communications, and electrical equipment, including the SXblue II-B GPS receiver. This will reduce the amount of noise present at the antenna, improving beacon receiver performance.
- Install the antenna in the best location for the application, such as the center line of the vehicle or vessel. The position calculated by the beacon receiver is measured to the center of the antenna.
- Do not locate the antenna in areas that exceed environmental conditions that are specified.

2.4 Single Baseline RTK and RTK Networks

This section covers the basic aspects of Real Time Kinematic (RTK) positioning using either a single baseline corrections or using an RTK Network with virtual solution computation. RTK for base and rover modes is optional on SXblue receiver except with the Platinum RTK model.

First, it is important to stress that there are major differences between code-phase differential and carrier phase differential. The differences are explained here in a very simplistic way.

Code-phase differential uses pseudo range measurements (pseudo distances from the GPS/GLONASS satellites to the receiver's antenna) to achieve sub meter. When a rover receives the corrections from the reference station (or the SBAS satellite) it applies it right away to its own code measurements. In other words, in forestry applications for example, a position can be computed every second and if the rover loses lock on all satellites, at the very instant that a new valid position is computed, the correction is immediately applied and a DGPS position is output.

Carrier phase differential is a much more complex process and uses mainly the phase of the signal's wave carrying the code. It does not use the code, but rather the "envelop" which carries the code. This method counts the number of carrier cycles between the satellites and the receiver's antenna. The rover has to go through a process of solving for multiple unknowns to achieve the cm accuracy. This is the reason why an unobstructed clear view of the sky and a certain time (during this convergence time, the solution will be a float type solution, basically a code heavily polished with the carrier phase information) is required before the rover can achieve a fixed ambiguity solution. This is the reason why RTK cannot work properly in very challenging conditions such as forestry or dense urban canyon.

The performance (time to reach a fixed solution and accuracy) of a base/rover RTK setup depends on many factors. Below is a list of the most common ones:

- The baseline length. The longer the baseline length the more time required by the rover to fix the ambiguities. Also it should be noted that the 1cm specified horizontal accuracy is subject to a +1ppm
- The number of satellites. The more satellites available the faster the phase ambiguity resolution. A GNSS rover, receiving corrections for both GPS and GLONASS will usually “fix” much faster than a GPS-only rover.
- The satellite geometry (DOP).
- The quality of the transmitted signal. The age of the differential correction signal received by the rover should be kept as close to 1-2 seconds as possible. Greater latency will affect the performance of the rover.
- The quality of the antenna and its ability to reject multipath.
- A high multipath environment (nearby trees, buildings, etc)

The standard format for transmitting RTK corrections is called RTCM 3.0. The SXblue receiver (RTK activated) automatically detects an RTK correction coming in on any of its communication ports and starts using it. Unless the default settings have been changed, there is no other setup required. For example, an SXblue Platinum RTK using WAAS for sub meter and being fed RTK corrections to its serial port will automatically switch to RTK positioning after a few seconds. If the RTK correction is lost, it will revert to its original state after about 2 or 3 minutes. This automatic selection of the best differential correction source can fully be configured by the user.

2.4.1 Single Baseline RTK

Single baseline RTK is the conventional way of doing cm-level work. The system consists of a pair of receivers, one setup as base or reference station on a known (or arbitrary) reference point and the other receiver called the rover, doing the actual field work. Both receivers use carrier phase information and the reference station computes corrections that are sent to the rover via either a radio link (Spread Spectrum, UHF, etc) or via the Internet using a TCP IP protocol, commonly referred to as Direct IP (DIP).

The closer the rover to the reference station the better the accuracy. For single frequency RTK, the maximum baseline length recommended is 10 km. Note that the time to fix ambiguities is much longer for a single-frequency receiver and requires 3 to 10 minutes compared to a few seconds to 1-2 minutes for a multiple

frequency receiver. The maximum baseline recommended for dual-frequency operations is about 25-30 km.

- One limitation of the base/rover setup is the type of radio used. The broadcasting range of a radio is dependent upon a number of factors, including transmission power, free space loss, ionospheric state, surface conductivity, ambient noise, etc. Spread spectrum 1 Watt radios operating in the 900MHz or 2.4GHz offer usually very short range (500 to 1000m) but are relatively very inexpensive compared to UHF radios. They usually do not require licensing from local authorities. UHF radios, in the 430-470MHz range are more commonly used in the surveying industry but are also bulkier and more expensive. A 2 Watt transmitter can cover about 1-3 km whereas a 35 Watt transmitter can reach up to 12 km. The key to success for both types of radios is to set the transmitting antenna as high as possible above the ground to increase the propagating distance. UHF radios transmitting at high power (usually in excess of 2-4 Watts) require a license from the government authorities.

The expected range of a broadcast also depends upon the conductivity of the surface over which it travels. A signal will propagate further over a surface area with high conductivity than a surface with low conductivity. The line-of-sight wave has a substantial impact on the performance of the UHF and Spread Spectrum radios.

- The radio range limitation in a base/rover setup can be overcome by using the Internet on a cellular connection. Cellular phones do not allow direct TCP connections between them in the field, but a TCP server at the office can act as a relay between the base and the rover. A typical setup for such a configuration would require an SXblue Server installed on a PC in the office with the Mirror feature activated, an SXblue base station with a cell phone PDA running SXblue Mirror and sending the corrections to the office, SXblue receivers in the field all running SXblue RTN and connected to the mirror port of the SXblue Server. The advantages of such a solution are: no line-of-sight requirement for the RTK transmission from the reference station to the rover, baseline length can easily be increased but subject to adequate cellular phone coverage, cleaner, lighter and cheaper solution.

2.4.2 RTK Networks

Many authorities and private companies have installed Internet networks of reference stations that broadcast RTK corrections to users of this system. With the increasing utility of these networks for surveying applications, there is an increasing trend towards such a technology. Some of these networks are free of charge and others require a subscription. These networks follow a standard protocol called NTrip (Networked Transport of RTCM via Internet Protocol).

NTrip is a protocol for streaming differential GPS/GNSS (DGPS/DGNSS) data over the Internet. NTrip is a generic, stateless protocol based on the Hypertext Transfer Protocol HTTP/1.1 and is enhanced for GNSS data streams.

NTrip was developed by the German Federal Agency for Cartography and Geodesy (BKG) and the Dortmund University Department of Computer Science. NTrip was released in September 2004 as “RTCM Recommended Standards for Networked Transport of RTCM via Internet Protocol (NTrip), Verion 1.0”. The current version of the protocol is Version 2.0 with Amendment 1, June 28, 2011. NTrip is an open standard protocol. The protocol can be freely downloaded from BKG and there is an open source implementation available from their web site. Refer to Appendix D for useful links.

The basic architecture of such a system is as follows. GNSS reference station receivers are connected to NTrip Servers. These servers connect to a central server called the NTrip Caster. The individual servers appear as Mountpoints on the Caster. An NTrip Client in the field connects to the NTrip Caster and automatically downloads a table containing all the mountpoints. Most NTrip Casters offer both single baseline connection to a specific mountpoint and connection to a virtual mountpoint where a specific solution is computed based on user's location.

The main advantage of using an RTK network is the convenience of not having to operate a reference station (especially if the network is free and if adequate cellular phone coverage is available). These networks can cover a region, a state or a full country. One key feature as stated above is the ability of these networks to compute virtual solutions based on users' locations. The NTrip client such as the SXblue RTN (running on the user's computer), automatically handles the transmission of the user's location by sending the GGA message to the NTrip caster at a regular interval.

2.5 Atlas GNSS Global Correction Services (for SXblue Platinum)

Atlas® is a worldwide terrestrial DGPS service that provides correction data to subscribers of the system with the use of a geostationary transponder.

2.5.1 System Overview

Atlas® is a wide area DGPS service. The information broadcast by this service is based upon a network of reference stations placed at geographically strategic locations. The network stations communicate GPS correction data to control centers where it is decoded, checked, and repackaged into a proprietary format for transmission to a geostationary L-band communications satellite. The satellite rebroadcasts the correction information back to earth over a large signal footprint

where the SXblue Platinum, L-band differential satellite receiver, demodulates the data.

Atlas[®] signal content is not RTCM SC-104, but a proprietary wide-area signal that is geographically independent. With this service, the positioning accuracy does not degrade as a function of distance to a base station, as the data content is not composed of a single base station's information, but an entire network's information. When the SXblue Platinum L-Band receiver demodulates the proprietary signal, it converts it into a local-area format for input to the internal GPS receiver (standard RTCM SC-104).

The SXblue Platinum receiver interpolates corrections from the wide-area signal, specific to the location using Virtual Base Station (VBS) processing algorithms. The resulting RTCM corrections are those that would be calculated if a reference station were set up at the present location. This type of solution ensures a consistent level of accuracy across the entire coverage area.

2.5.2 Signal Reception

The Atlas[®] L-band signal is a line-of-sight signal that is similar to GPS. There must be a line of sight between the SXblue antenna and the geostationary communication satellite in order for the L-band differential receiver inside the SXblue Platinum to acquire the signal.

Various L-band communications satellites are used for transmitting the correction data to Atlas[®] users around the world. When the SXblue Platinum has acquired an Atlas[®] signal, the elevation and azimuth are available in the menu system in order to troubleshoot line of sight problems. Contact Atlas[®] for further information on this service and actual worldwide signal broadcast coverage maps. Atlas[®] contact information is provided in Appendix C of this manual.

The Atlas[®] service broadcasts at a similar frequency to GPS, and as a result, is a line-of-sight system. There must be a line of sight between the antenna and the Atlas[®] satellite for reception of the service.

The Atlas service uses geostationary satellites for communication. The elevation angle to these satellites is dependent upon latitude. For latitudes higher than approximately 55° north or south, the Atlas signal may be blocked more easily by obstructions such as trees, buildings, terrain, or other objects. In this case, the Coast technology described below might enhanced the field performance of the SXblue Platinum when used with the sub-meter VBS service.

2.5.3 Automatic Tracking and Performance

The SXblue Platinum features an automatic mode that allows tracking of the best spot beam if more than one is available in a particular region. The L-band DGPS receiver's frequency does not need to be adjusted with this function. The SXblue Platinum also features a manual tune mode for flexibility.

The Atlas receiver provides both a lock icon and a BER to describe the lock status and reception quality. Both of these features depend on a line-of-sight between the antenna and the geostationary communications satellite broadcasting Atlas correction information.

The SXblue Platinum antenna is designed with sufficient gain at low elevation angles to perform well at higher latitudes where the signal power is lower and the satellite appears lower on the horizon.

The BER number indicates the number of unsuccessfully decoded symbols in a moving window of 2048 symbols. Due to the use of forward error correction algorithms, one symbol is composed of two bits.

The BER has a default, no-lock value of 500. As the receiver begins to successfully acquire the signal, it will result in a lower BER. For best operation, this value should be less than 150 and ideally less than 20.

2.5.4 Available Services

There are three (3) levels of **satellite differential correction services for GNSS** available from **Atlas** that require a subscription with the company:

- **Atlas Basic: 50 cm 95% (30 cm RMS)**
- **H30: 30 cm 95% (15 cm RMS)**
- **H10: 8 cm 95% (4 cm RMS)**

- **Atlas Global Correction Services for GNSS** are being introduced across a wide range of multi-frequency, multi constellation, and RTK-capable hardware, available worldwide.

- **Atlas** is delivering its correction signals via L-Band satellites or IP address at accuracies ranging from meter to sub-decimeter levels. With approximately 200 reference stations worldwide and L-Band satellites distributing coverage from 75°N to 75°S, all of the earth's landmass is covered.

- Scalable service levels: **Atlas** is capable of providing virtually any accuracy, precision and repeatability level in the 5 to 100 cm range.

- Positioning accuracy: Atlas provides competitive positioning accuracies down to 2 cm RMS in certain applications.
- Positioning Sustainability: Position quality maintenance in the absence of correction signals, using Hemisphere's Tracer technology.
- Convergence Time: Convergence times of 10 – 40 minutes.
- Network RTK augmentation: BaseLink technology allows Atlas-capable receivers to self-calibrate, self-survey, and automatically manage the transmission of RTK correction data to augment or extend established or new GNSS reference networks in areas of poor Internet connectivity.

2.6 COAST™ and SureTrack™ Technologies

The SXblue receiver is packed with features that make it unique on the market. Coast technology affect positively the sub meter performance of the receiver, whereas SureTrack is related to the sub meter and RTK performance.

- The SXblue receiver incorporates the **COAST™** technology that allows it to operate with old correction data for up to 35 to 40 minutes or more without significant accuracy degradation. The feature's performance is attributed to sophisticated algorithms that are able to anticipate how errors change during a period of correction loss.
Traditional receiver technology would experience an increasing degradation with increasing age of corrections, resulting in less than adequate performance over a shorter period of time. **COAST** technology provides more consistent positioning during periods when signal loss occurs, thus bridging the gap to when the signal is reacquired. This means that the SXblue receiver is more tolerant than competing products to loss of SBAS, Atlas or externally input RTCM SC-104 corrections.
- The **SureTrack** feature allows the SXblue receiver (GNSS model) to use GLONASS with GPS-only corrections. For example, all SBAS (besides, eventually, the Russian SDCM) only broadcast corrections for GPS satellites and contain no GLONASS corrections. When tracking an SBAS signal, the SXblue receiver will use its DGPS solution along with other parameters to generate its own GLONASS corrections. With SureTrack technology the RTK rover makes use of every satellite it is tracking, even satellites not tracked at the base. This results in fewer RTK dropouts in congested environments, faster reacquisitions and more robust solutions due to better cycle slip detection. SureTrack also removes concerns with using various manufacturers GNSS base. Even if the GNSS base delivers L1/L2 GPS, SureTrack with GLONASS at the rover will deliver the RTK performance. This unique feature of using all satellites in view, provides with

the advantages of all the extra GLONASS observations required in tough and challenging conditions.

2.7 Real-Time Differential Options

Real-time differential options can be added to your SXblue receiver. These options are made available depending on the installed firmware and the subscription/activation. See Chapter 3 for more information on firmware architecture and activating options (RTK, Atlas, Multi-GNSS, Multi-Freq, 10Hz, and 20Hz).

- Multi-Function Application, called the **MFA**: SBAS, DGPS input (RTCM 2.x), RTK (RTCM 3.x, CMR, CMR+), and Atlas L-Band (H10, H30 and H100).
- Multi-Frequency (L1-L2-L5) and Multi-GNSS (GPS, GLONASS, Galileo, BeiDou, QZSS and SBAS)
- **RTK Application**: RTK (RTCM 3.x, CMR, CMR+)

2.7.1 The “MFA” Application

The SXblue Series comes standard with the Multi-Function Application (MFA) installed which includes all the features of both the SBAS and RTK applications. The SXblue Platinum RTK comes standard with the M-Freq, M-GNSS and RTK options pre-activated. The SXblue Platinum and Platinum AG include the Atlas L-Band support. The Multi-Function Application allows a few real-time input/output options:

- Tracking and receiving differential corrections from an SBAS signal
- Tracking and receiving differential corrections from RadioBeacon (SXblue II-B)
- Receiving differential (RTK) correction from an external source
- Relaying/outputting the SBAS correction received in an RTCM format (acting basically like a mobile base station or source of differential correction for another receiver). Since all communication ports are fully independent, the RTCM can be output on one port (ex. RS-232) while NMEA position data are sent to a different port (ex. Bluetooth).

Table 2-1 Differential and Global Options

Receiver Model	SBAS	GPS	GNSS	M-Freq	RTK	L-Band	10Hz	20Hz
SXBlue 12/24 Volt	•	•	Optional	X	Optional	X	Optional	Optional
SXBlue II	•	•	Optional	X	Optional	X	Optional	Optional
SXBlue Platinum	•	•	Optional	Optional	Optional	•	Optional	Optional
SXBlue Platinum AG	•	•	Optional	Optional	Optional	•	Optional	Optional

2.7.2 The L-Band Application

The SXblue Platinum standard configuration is GPS/SBAS with MFA application installed. Atlas L-Band can be activated with subscription and then comes automatically with Multi-GNSS, RTK and Multi-Frequency option.

2.7.3 RTK Differential options

RTK differential is an application to use and apply correction from reference station. This application can be used between two SXblue receivers. One receiver is used as the base station and must remain stationary. It is extremely useful to know the coordinates of the base station position, but averaging the position will also suffice. The second receiver is used as a rover and the messages (correction) must be sent through a communication system. Various types of radio-modem technology are available (UHF, 900MHz, 2.4GHz, cellular, etc.) to suit the application.

The RTK application can perform the following:

- Differential (DGPS) solution 20cm floating solution
- RTK fixed solution 1-3cm with OTF (On-The-Fly) capability

For the RTK application, the baseline length (distance between base station and rover) should be kept short (less than 10km) for fixed solution. The positioning performance of the receiver in RTK modes is dependent upon the environment of the base and rover receivers, the distance between them and the accuracy of the entered coordinates of the base station. We suggest that you perform your own testing at your location to determine the level of performance that you would expect to see on average.

2.8 Post Processing

The SXblue receiver is able to output raw measurement data for post processing applications. The raw measurement and ephemeris data are contained in various binary messages documented in the Technical Reference Manual. Messages must be logged in a binary file (SXblue Config allows logging of raw binary data). For cm-level post-processing, a survey grade L1/L2 GNSS antenna with ground plane is highly recommended and software that processes the carrier phase like EZSurv should be used.

A RINEX translator is available; however, RINEX has no facility to store station information. Please contact SXblue GPS if you wish to use this utility. Off-the-shelf software is available for collecting and post-processing SXblue data.

Various types of post-processing can be performed: Static, semi-kinematic, kinematic, code-phase, phase, using L1 only or L1/L2, GPS only or GNSS, with a local base station or using PPP. Refer to the post-processing software documentation for recommended occupation times to achieve the highest possible performance.

2.9 Evaluating the SXblue Performance

The SXblue receiver performance has been evaluated with the objective of determining best-case performance in a real-world environment. Static testing has shown that the SXblue achieves a performance better than 60cm 95% of the time when using SBAS signal (WAAS, EGNOS, GAGAN or MSAS) and better than 3cm when using a reliable RTK signal.

The qualifier of 95% is a statistical probability. Often you may see manufacturers using a probability of ‘rms’ or standard deviation. Performance measures with these probabilities are not directly comparable to a 95% measure since they are a lower probability (less than 70% probability). This means that less often, a product would position within a radius of the prescribed amount.

The following table summarizes the common horizontal statistical probabilities.

Table 2-2 Horizontal Accuracy Probability Statistics

Accuracy Measure	Probability (%)
RMS (root mean square)	63 to 68
CEP (circular error probability)	50
2dRMS (twice the distance root mean square)	95 to 98
R95 (95% radius)	95

It is possible to convert from one statistic to another using the following table. Using the value where the ‘From’ row meets the ‘To’ column, multiply the accuracy by this conversion value.

Table 2-3 Horizontal Accuracy Statistic Conversions

		To			
		CEP	RMS	R95	2dRMS
From	CEP	1	1.2	2.1	2.4
	RMS	0.83	1	1.7	2.0
	R95	0.48	0.59	1	1.2
	2dRMS	0.42	0.5	0.83	1

For example, if Product A after test results in an accuracy of 90 cm 95% (R95) and you want to compare this to Product B that has a sub-meter horizontal RMS specification, select the value from where the 'R95' row and the 'RMS' column intersect (to convert to RMS). You will see that this conversion value is 0.59. Multiply the 90 cm accuracy by this conversion factor and the result will be 53 cm RMS. If you now compare this to Product B's specification of sub-meter RMS, you can see the Product A would offer better performance. To properly evaluate one receiver against another statically, they should be using identical correction input (from an external source) and also share the same antenna using a power splitter (equipped with appropriate DC-blocking of the receivers and a bias-T to externally power the antenna). With this type of setup, the errors in the system are identical with the exception of receiver noise.

Although this is a comparison of the GPS performance quality of a receiver, it excludes other performance merits of a GPS engine. The dynamic ability of a receiver should be compared in a similar way with the test subjects sharing the same antenna. Unless a receiver is moving, its software filters are not stressed in a similar manner to the final product application. When testing dynamically, a much more accurate reference would need to be used, such as an RTK system so that a 'truth' position per epoch is available.

Further, there are other performance merits of a GPS engine, such as its ability to maintain a lock on GPS and SBAS satellites. In this case, the same GPS antenna should be shared between the receiver test subjects. For the sake of comparing the tracking availability of one receiver to another, no accurate 'truth' system is required, unless performance testing is also to be analyzed. Again, an RTK system would be required; however, it's questionable how its performance will fair with environments where there are numerous obstructions, such as foliage. Other methods of providing a truth reference may need to be provided through observation times on surveyed monuments or traversing well-known routes. Again, be aware that the coordinates output by the SXblue receiver, with no differential correction, are in the current GPS WGS84 (G1674) datum (which follows ITRF 2008, epoch 2005).

The GPS antenna included should be mounted pursuant to the following requirements:

- The SXblue receiver computes a position based upon measurements from each satellite to the location of the GPS antenna's phase center. Mount the GPS antenna in the location for which you desire a position. When choosing a location to mount the antenna, please ensure that there is an unobstructed hemisphere of sky available to the GPS antenna. This will ensure that GNSS and SBAS satellites are not masked by obstructions, potentially reducing system performance.
- It is important to locate any transmitting antennas away from the GNSS antenna by several feet or more. This will help to ensure that tracking

performance of the SXblue is not compromised, giving you the best performance possible.

- Make sure that there is sufficient length of the antenna extension cable available in order to be able to connect it to the SXblue enclosure.

If you require assistance in developing a test setup or procedure for evaluating the SXblue receiver, please contact SXblue GPS.

2.10 Communication

The SXblue receiver features three (3) independent communication ports (except SXblue 12/24 volts) and any of these can be used to receive data or send configuration commands to the receiver.

2.10.1 Interface

- **NMEA 0183** Message Interface. The SXblue receiver uses an NMEA 0183 protocol for interfacing, which allows you to output standard messages recognized by any off-the-shelf GNSS data collection software. The NMEA interface also allows to easily making configuration changes by sending text-type commands to the receiver. Relevant commands for the configuration changes are presented in the following chapter or in the Technical Reference Manual.
- **Binary** Message Interface. In addition to the NMEA interface, the SXblue also supports a selection of binary message outputs. There is a wider array of information available through the binary messages, plus binary messages are inherently more efficient with data. If your application has a requirement for raw measurement data, for instance, this information is available only in a binary format. Consult the Technical Reference Manual for more information on Binary messages.

2.10.2 Bluetooth, USB and Serial Ports

- **Bluetooth** is a wireless communication technology that enables seamless data connections between a wide range of devices through short-range digital two-way radio. The SXblue receiver is equipped with Bluetooth technology and requires another Bluetooth device with which to communicate (a Bluetooth-capable tablet PC for example). The Bluetooth wireless module inside the SXblue is a power class 1 device supporting version 2.0 of the Bluetooth standard, and has been certified. Some model are equipped with version 2.1 +EDR iOS compatible. As mentioned in the

previous chapter, the SXblue receiver does not require pairing (or bonding, or authentication) using passwords (or pass codes, passkeys, etc).

- The **USB** port (not available with SXblue 12/24 volts) on the back panel is of Type B and requires a driver to be installed on the computer in order to emulate a serial port. See section 1.3 for USB driver installation.
- There is one **Serial Port** on the SXblue receiver and it is compatible with the RS-232C interface level to communicate with external data loggers, navigation systems, PC computers, Pocket PC and other devices. This serial port is accessible via the back panel of the SXblue enclosure and has an 'RS-232' label. You can interface most devices to the SXblue receiver directly with the serial cable (supplied with your receiver), accommodating any gender changes necessary, or with the addition of a null modem as necessary.

The following figure and table detail the pin assignment of the DB-9 connector of the serial port (DCE Mode) of the SXblue receiver. The Pulse Per Second output (PPS), Event Marker (EM) and 5Volt Power are available only upon request.

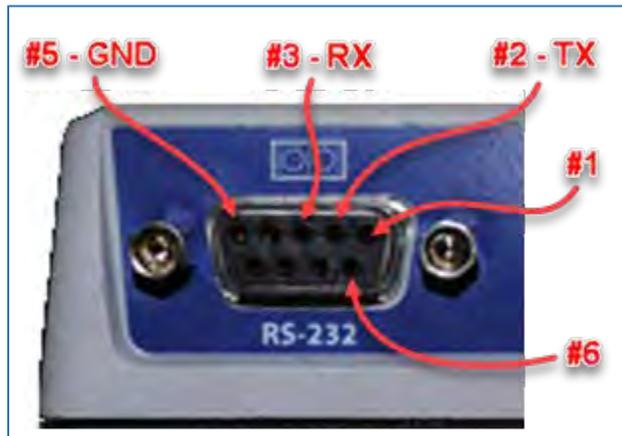

Figure 2-3 RS-232 Connector Pin-out

Table 2-4 Serial Port Pin-out, RS-232C Interface Level

<i>For SXblue II series, SXblue III series, and SXblue Platinum series</i>		
Pin	Signal	Description
2	TXD	NMEA 0183, binary, and RTCM (output)
3	RXD	NMEA 0183, binary, and RTCM (input)
5	GND	Signal Ground
6	1PPS	One Pulse Per Second (Output)
8	EM	Event Marker (Input)
9	PWR	Power 5VDC @ 100mA (max) (Output)

Note - For successful communications, the baud rate of the SXblue receiver serial ports must be set to match that of the devices to which they are connected. Technical Reference Manual describes the \$JBAUD baud rate change command.

2.10.3 Event Marker, 1 Pulse per Second and 5Vdc Power

The 1PPS, EM and 5Vdc Power are available upon request on the DB-9 connector when ordering the SXblue receiver. These features can also be activated after purchase but you will need to contact your local reseller.

2.10.3.1 One Pulse per Second (1PPS)

The one pulse per second (1 PPS) timing signal is used in applications where devices require time synchronization.

The 1 PPS signal is 3.3V HCMOS normally low with rising edge synchronization. The 1 PPS signal is capable of driving a load impedance which is greater than 10 k Ω in parallel with 10 pF capacitor. The pulse is approximately 1ms long.

2.10.3.2 Event Marker Input (EM)

Depending on your application, you may have the need to force a GPS solution at a particular instance, not synchronized with GPS time. Such an application could be to compute the location of a perspective center of a camera being used for a photogrammetric application, where the aircraft moves with considerable speed and an interpolation between two GPS epochs could be unreliable.

The Event Marker input is active low 3.3V HCMOS with falling edge synchronization. The input impedance and capacitance is higher than 10 k Ω and 10 pF respectively, with a threshold of lower than 0.7V required to recognize the input.

Upon detecting an Event, the SXblue receiver will output immediately the set of strings it has been configured to output. Also it is worth noting that binary message (Bin1) has a field reserved for the event marker. See Technical Reference Manual for more information.

2.10.3.3 5 volts DC Output (PWR)

Some external sensor might require a 5Vdc power source. An example can be attaching an RS-232 Bluetooth or Wi-Fi dongle to the receiver. The SXblue

receiver will supply up to 100mA to power the external device. Care must be taken not to short-circuit this input.

2.11 Environmental Requirements

The equipment supplied with the SXblue system has specific environmental limits that you should ensure are met when storing and using the system.

The SXblue receiver is designed to be stored between -40°C and +85°C. The operating temperature range is -40°C and +85°C. Note that Li-Ion battery performance degrades below -20°C. The SXblue receiver and antenna are designed to operate in an outdoor environment with 100% relative humidity.

3. Advanced Operations

This chapter introduces the general operational features of the SXblue receiver and configuration procedures.

3.1 Communicating with the SXblue receiver

The SXblue receiver features three communication ports (except SXblue 12/24 volts) that may be configured independently from each other (Bluetooth, Serial and USB). The ports may be configured for any mixture of NMEA 0183, binary, and RTCM SC-104 data. The usual data output is limited to NMEA data messages since these are industry standard. When sending commands to configure the SXblue receiver, these ports are referred to as:

- Port A (Bluetooth)
- Port B (Serial)
- Port C (USB)

Note - If you require different data types to be output from the SXblue receiver simultaneously (such as NMEA and binary or NMEA and RTCM), ensure that the software used for logging and processing of the data has been designed to correctly parse the different data types from the single stream of data. Alternatively, you may also use any two ports to separate the different data types and set at different output rates.

3.1.1 NMEA 0183 Interface

NMEA 0183 is a communications standard established by the National Marine Electronics Association (NMEA) and provides data definitions for a variety of navigation and related equipment. Such instruments supported include gyrocompasses, Loran receivers, echo sounders, GPS receivers, and more. NMEA functionality is virtually standard on all GPS equipment available. NMEA has an ASCII character format that allows you to read the data via terminal software on the receiving device (if possible). One second of example NMEA data from the SXblue receiver follows:

```
$GPGGA,141823.00,4536.79732,N,07333.95861,W,2,09,1.0,49.6,M,-32.4,M,5.4,0313*4E
$GPVTG,151.61,T,,M,0.08,N,0.15,K,D*36
$GPZDA,141823.00,9,7,2004,00,00*63
$GPGSA,M,3,06,08,10,17,18,21,24,26,29,,,,1.7,1.0,1.3*31
$GPGSV,3,1,11,06,40,234,48,08,18,056,42,10,43,066,45,16,00,319,*7F
$GPGSV,3,2,11,17,43,121,45,18,21,264,45,21,39,304,45,24,10,125,45*7E
$GPGSV,3,3,11,26,69,160,48,27,07,031,39,29,73,109,45,,,,*45
```

The SXblue receiver supports a variety of standard and proprietary NMEA messages. These messages are used to configure the receiver and also contain the required information from the SXblue receiver. You may configure a selection of NMEA 0183 data messages on one port at various update rates (each message has a maximum update rate) and a different selection of NMEA 0183 messages with different rates on the other port.

Technical Reference Manual presents information relating to the NMEA interface of the SXblue receiver. Appendix C - Resources provides contact information, should you wish to purchase a copy of the NMEA 0183 standard.

3.1.2 Binary Interface

Binary messages may be output from the SXblue receiver simultaneously as NMEA 0183 data. Binary messages have a proprietary definition and would likely require custom software support if you wish to use them. Binary messages are inherently more efficient than NMEA 0183 and would be used when you require maximum communication efficiency. Use of binary messages for most users is not recommended - the NMEA interface allows you to control the operation of the SXblue and also receive most types of information regarding status and positioning information.

Note – If you wish to log binary data, please ensure that your logging software has opened the file as a binary file, otherwise you may lose data.

3.1.3 RTCM SC-104 Protocol

RTCM SC-104 is a standard that defines the data structure for differential correction information for a variety of real-time differential correction applications. It has been developed by the Radio Technical Commission for Maritime services (RTCM) and has become an industry standard for communication of correction information. RTCM is a binary data protocol and is not readable via a terminal program. It appears as 'garbage' data on-screen since it is a binary format and not ASCII text. The following is an example of how the RTCM data appears on-screen:

```
mRMP@PJfeUtNsmMFM{nVtIOTDbA^xGh~kDH`_FdW_yqLRryrDuhcB\@}N`ozbSD@O^}
nrGqkeTlpLLrYpDqAsrLRrQN{zW|uW@H`z]-aGxWYt@I`_FxW_qqLRryrDCikA\@Cj]DE]]
E@w_mlroMNjkKOsmMFM{PWDwW@HVEbA^xGhLJQH`_F`W_aNsmMFM[WVLA\@S]a
mz@illuPqx~_IZhTCpLLrYpdP@kOsmMFM[kVDHwVGbA^P{WWuNt_SW_yMsmMnqdrh
cC\@sE^ZfC@}vJmNGAHJVhTCqLRryrdviStW@H_GbA^P{wxu[K
```

RTCM has various levels of detail; however the highest level is the message. RTCM defines numerous messages that contain specific information. The SXblue receiver supports more advanced methods of differential positioning, such as real-time kinematic (RTK) that uses different standard RTCM message types. The

SXblue receiver uses standard (RTCM 2.x and RTCM 3.x) and proprietary (ROX, CMR, CMR+) real-time correction messages to achieve cm-level RTK.

In very simple words here are the various version of RTCM SC-104 and their usage:

- RTCM 2.0 - Pseudorange corrections for GPS L1 C/A code only. Usually used for sub meter positioning.
- RTCM 2.1 – Added GPS-only L1 carrier phase message to v2.0 for single frequency RTK.
- RTCM 2.2 – Equivalent to 2.0 with the addition of the GLONASS pseudorange corrections.
- RTCM 2.3 – Equivalent to 2.1 with single frequency carrier phase corrections for both GPS and GLONASS.
- RTCM 3.1 – Sends dual-frequency corrections for both GPS and GLONASS for the highest level of performance for RTK work.

Note - RTCM is a local area data standard. This means that when positioning with external correction, performance will degrade as a function of distance from the base station. The additional degradation will depend on the difference in observed orbit and ionospheric errors between the reference station and the remote unit. This error is often seen as a bias in positioning, resulting in a position offset. The scatter of the receiver is likely to remain close to constant. RTK Networks overcome the limitations of relatively short baseline length (distance between rover and base) with sophisticated interpolation techniques.

SBAS (WAAS, EGNOS, MSAS, GAGAN) use a different correction format called RTCA. When using SBAS (and \$JMODE, BASE is set to “NO”, see chapter 5) The RTCM SC-104 data output by the SXblue is converted from the RTCA SC-159 data broadcast by the SBAS networks. Appendix C - Resources contains the contact information should you wish to purchase a copy of the RTCM SC-104 specification.

3.2 Configuring the SXblue Receiver

The SXblue receiver features three bi-directional ports (except SXblue 12/24 volts) referred to as Bluetooth (Port A), Serial (Port B) and USB (Port C). GPS data messages for all ports are easily configured by sending NMEA commands to the SXblue receiver through either of its communication ports (the output of the Serial Port can be configured through the Bluetooth port for instance and vice versa). The \$JASC NMEA message discussed in detail in the Technical Reference Manual

allows you to turn messages on and off as you require as well as setting their output rates.

Our free utility **SXblue Config** are available to configure the SXblue receiver, send commands, query the receiver, view the receiver's output stream, and activate options under subscription. These commands are described in the Technical Reference Manual. The following items are examples of user-configurable features:

- Selecting one of the differential correction type (SBAS, DGPS, RTK, etc)
- Setting the baud rate of the serial RS-232 port or the USB port (Bluetooth baud rate is fixed)
- Choosing which NMEA data messages to output on each of the ports and the update rate of each message
- Setting the maximum differential age cut-off
- Setting the satellite elevation angle cut-off mask

Note – When turning messages ON at a specific baud rate, make sure the number of messages sent do not “saturate” or overflow the communication port. The Bluetooth port’s factory default is 115 200 baud and can be set higher (up to 230 400 baud) upon request.

3.2.1 Using SXblue Config

This section describe how to install **SXblue Config** application in order to configure or retrieve information from the SXblue receiver.

You can download **SXblue Config** application from our SXblueGPS.com web site under the SXblue Softwares tab using the following link:
<http://www.sxbluegps.com/download/>

First connect the SXblue receiver with the computer using USB (or serial) cable. Check the Windows Settings to find out which com port number has been allocated to the USB (or serial) connection. See the following illustration.

Start **SXblue Config** application and select the Port number and Baud Rate as illustrated. See the following illustration.

Press **Search** button to establish the connection with SXblue receiver. See the following illustration.

On the next screen, press **Advanced** button in order to access to all configuration option. See the following illustration.

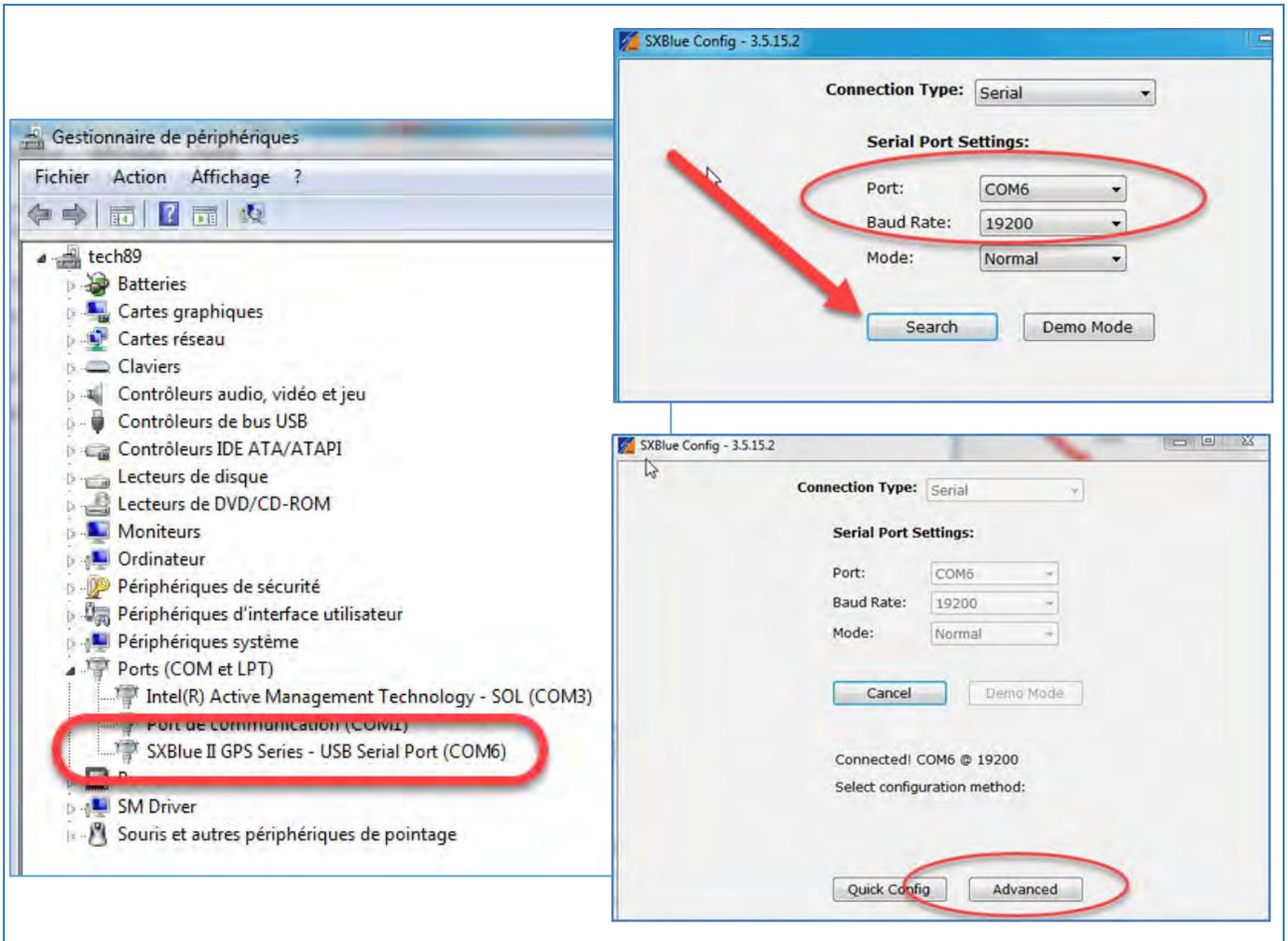

From SXblue Config, select the **About** tab (last tab) from the application to see all the information regarding the receiver including actual activation (subscription) and Firmware version. These information are required to check serial number, firmware version, update available and installed activations.

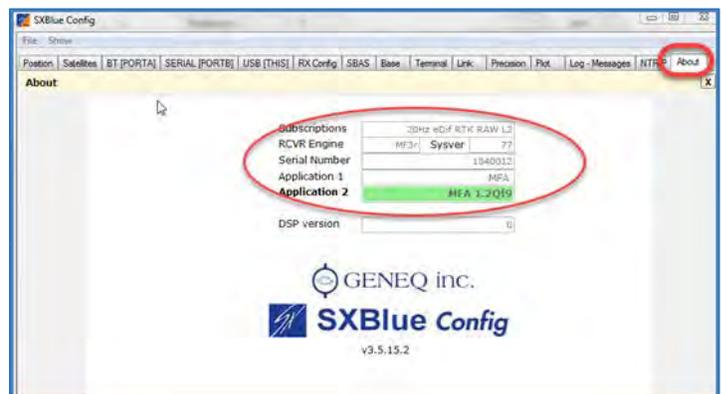

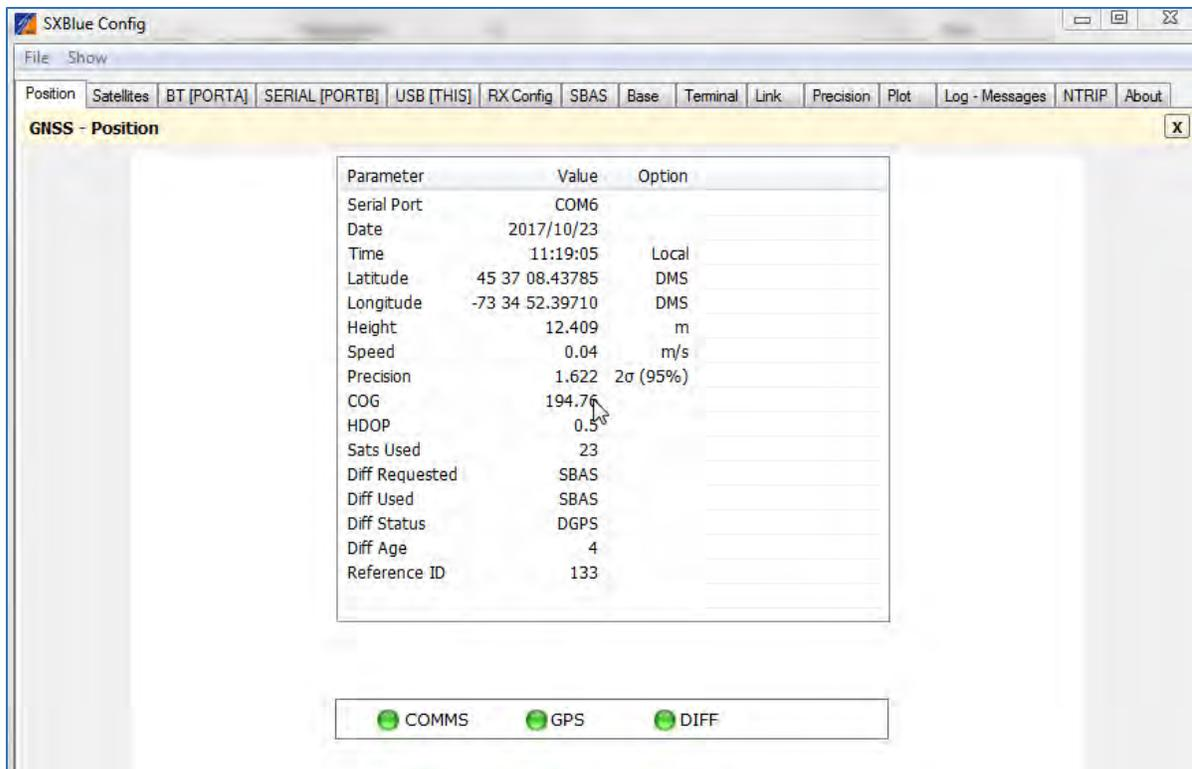

The **Position** tab (first tab) shows the status of the SXblue receiver. Default SBAS solution should be used as input differential correction source or DGPS RadioBeacon (SXblue II-B). The **Diff Requested** can be changed at the **RX Config** tab.

The **Satellites** tab shows the tracking status of the SXblue receiver. See illustration next page.

GPS data messages such as NMEA 0183, binary, and RTCM SC-104 can be configured with the following tab:

- **BT [PORTA]** for Bluetooth communication
- **SERIAL [PORTB]** for serial port RS232
- **USB [THIS]** for USB communication actually connected

Note: **Tab and Com Port** associated are different when SXblue 12/24 volt and Platinum AG are connected with **SXblue Config** application since these units don't use USB.

From the **RX Config** tab, you can change the **Diff Source** such as RTCM correction from external UHF radio connected to Serial Port B. See illustration next page.

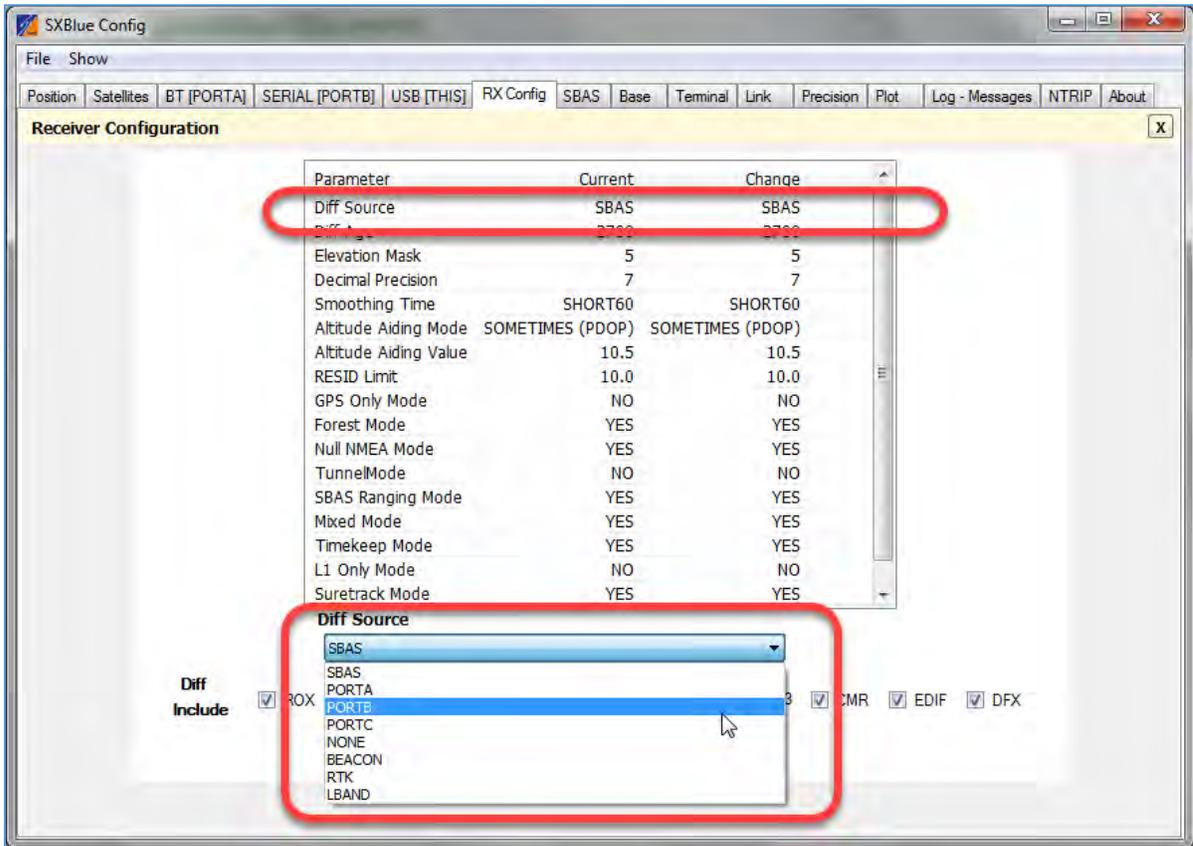
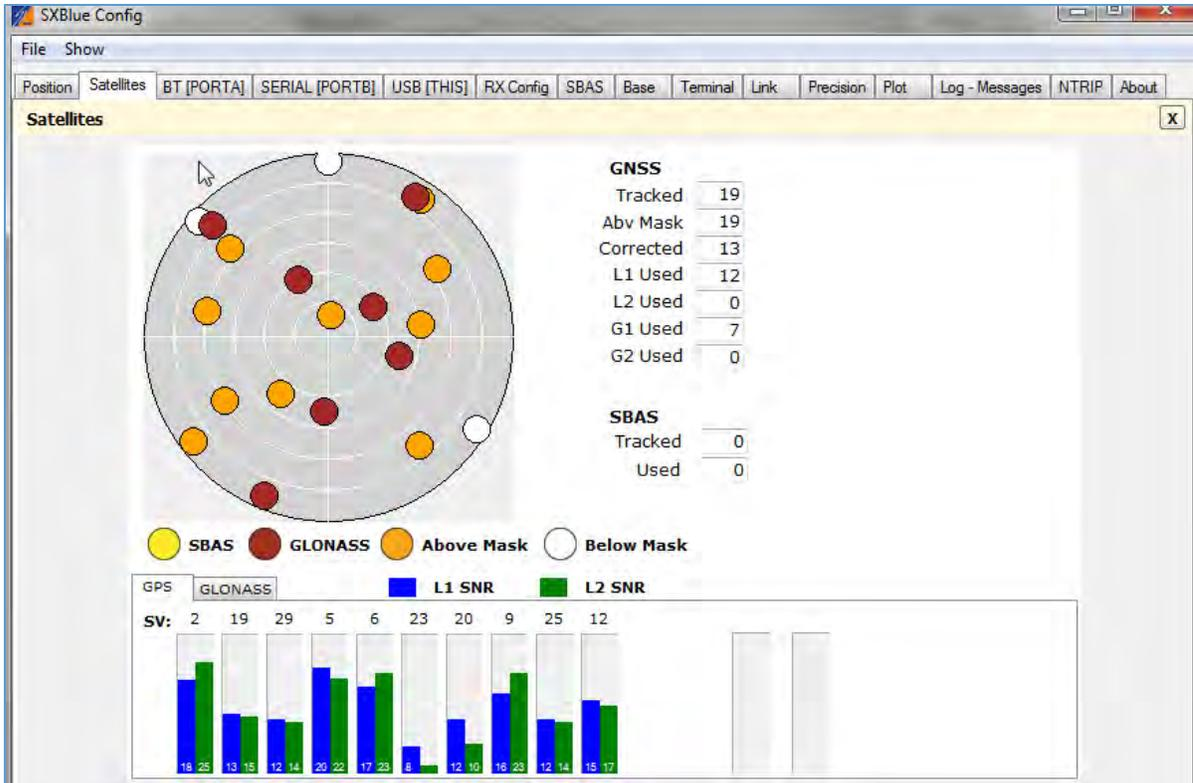

From **Log – Messages** tab, it is possible to log RAW data for post processing.

3.2.2 Activating an Option

These instructions explain how to activate an option on SXblue receiver. The subscription code must be purchased from SXblue GPS or an authorized representative.

Example of available option for SXblue receiver:

- 10 and 20 Hz Output Rate options
- Multi-GNSS activation
- Multi-Frequency activation
- RTK activation
- L-band activation and subscription

Some information are needed from the SXblue unit in order to proceed to the purchase.

Select the **Terminal** tab from the application. **Terminal** shows results of command sent to the receiver. Send the following command (see illustration below):

\$JI

\$JK,SHOW

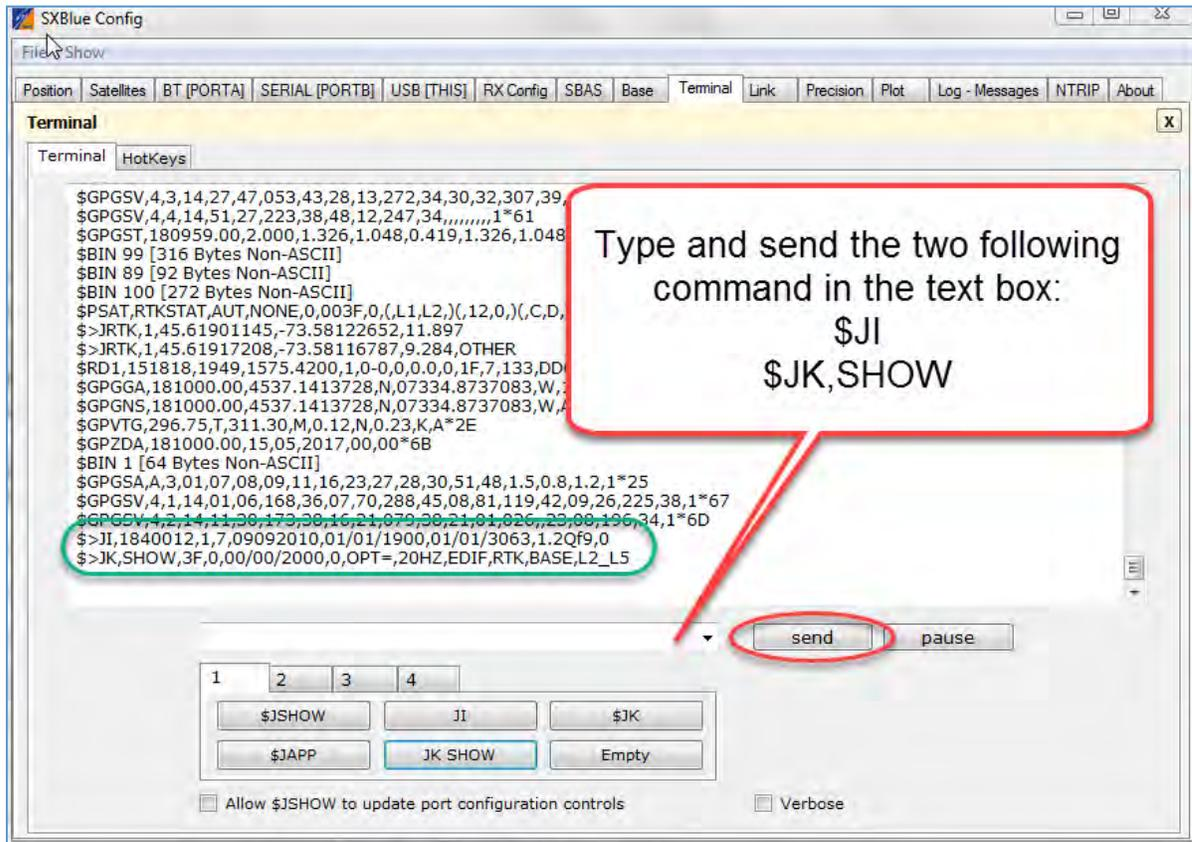

The information shown in the green box are required to order new option or activation for the receiver. Copy the displayed responses and send them to info@sxbluegps.com with a message requesting an activation subscription code.

Once you receive the activation code from SXblue GPS Inc., use the same **Terminal** tab from the application **SXblue Config** to enter (send button) the activation code. See the example below highlighted with yellow.

19081327 (related to unit serial number)

Activation(100):

\$JK,7B7C922911D94AC6F68677E5FC50C2F095064F00E12D4D3102CD0014

Atlas L-band subscription use the same activation process. At the **Position** tab under "Diff Requested" parameter, it should be **LBAND**

The "Diff Used" parameter will be **ATLAS**

For more information about Atlas command, see the Technical Reference Manual.

3.3 DGPS RadioBeacon Operation (SXblue II-B GPS)

The SXblue II-B GPS may be operated in Automatic mode, Manual Tune or Database mode. In **Automatic mode**, the receiver will identify and tune to the station providing the strongest DGPS signal using two receiver channels. In **Manual mode**, you specify the frequency to which the receiver will tune. In Manual mode, only the primary receiver channel is used. In **Database mode**, the receiver will search for the closest station based on its current location and distance to the internal list of station locations.

Refer to Technical Reference Manual for commands relating to changing the operating mode and monitoring receiver performance.

3.3.1 Automatic Mode

- **Automatic Beacon Search (ABS) Mode**

The SXblue II-B GPS operates in ABS mode by default, selecting and tuning to the most appropriate beacon without operator intervention. The SXblue II-B GPS uses its two independent channels to identify and lock to the best DGPS beacon.

ABS mode is ideal for navigation applications over considerable areas with various beacon stations available, eliminating the need for operator intervention when traveling from one beacon coverage zone to another.

- **ABS Global Search**

When powered for the first time in ABS mode, the SXblue II-B GPS initiates a Global Search (GS), examining each available DGPS beacon frequency, and recording Signal Strength (SS) measurements in units of decibel micro volts to the Global Search Table. The receiver uses these measured values to compute an average SS, noise floor and to sort the frequencies in descending order of SS.

This initial phase of the GS takes approximately 3 to 4 seconds to scan all 84 beacon channels in the frequency band using both channels. Once scanned, and with SS numbers identified for each beacon channel, both receiver channels cooperatively examine the frequencies with the highest SS measurements, above the computed noise floor, to determine the station providing the strongest RTCM signal. The receiver's primary channel locks to the first identified DGPS broadcast, while the second channel continues searching in the background for superior beacon signals. If no signal is available, the SXblue II-B GPS will initiate a fresh GS, continuing this cycle until it finds a valid beacon.

The secondary acquisition phase of the GS composes the remainder of the time required to acquire the beacon signal. The time required to acquire a beacon in ABS mode is dependent upon the signal quality of DGPS beacons in your area, and their relative strength to other non-DGPS beacon

signals in the 283.5 to 325.0 kHz band. As this frequency range is a navigation band, it is shared with other navigation aides such as non-directional beacons used for aviation and marine navigation. Depending on the signals available, initial acquisition may take less than 15 seconds for a strong beacon station, from a cold start or up to a couple minutes if a beacon site is weak relative to other signals. During the acquisition phase, if bit errors occur due to a weak DGPS beacon signal or environmental noise occurs, the time to acquire may be longer.

- **ABS Background Search**

During the Background Search, the second channel examines all frequencies at both the 100 and 200 bps MSK bit rates to identify beacons possessing superior signal quality. If a DGPS broadcast is identified that exhibits a 2dB greater signal strength than that of the primary station, the receiver will automatically switch to this beacon. No loss of lock occurs on the primary station during the background scan process. If the secondary receiver channel finds a superior station, the main channel is instructed to tune to the new beacon.

The SXblue II-B GPS stores the current primary beacon in memory so that it is available upon subsequent power-up. You may force a new GS at any time using the \$PCSI,4 proprietary NMEA 0183 command defined in the Technical Reference Manual.

3.3.2 Manual Mode

In Full Manual Tune mode, you may specify a frequency and bit rate for the receiver to tune to or specify the frequency only, allowing the SXblue II-B GPS to identify the correct MSK bit rate automatically (Partial Manual Tune mode). Setting manual operation is discussed in the Technical Reference Manual, using the \$GPMSK NMEA 0183 command.

Acquisition of a beacon in manual tune mode is dependent upon the data rate of the station. In Full Manual Tune mode with an MSK rate of 200 bps, signal acquisition should occur within 5 seconds if no demodulation errors occur. Signal acquisition should occur within 10 seconds for a modulation rate of 100 bps provided that no demodulation errors occur.

Partial Manual Tune mode requires that the SXblue II-B GPS identify the correct MSK rate automatically. This automatic detection could result in signal acquisition rates of up to approximately 15 seconds.

3.3.3 Database Mode

- **Operating Mode**

This operating mode has been added to the SXblue II-B GPS in order to be compliant with the specification IEC 61108-4 for ship borne DGPS maritime radio beacon receiver equipment. The basic operation is outlined below.

1. The receiver will determine the 10 closest stations after computing a valid position. This list can be accessed using the command \$PCSI,3,2.
2. The primary channel tries to tune to the closest available station, using the frequency and bit rate specified in the station database.
3. The background channel tunes to the frequency of the closest station using an alternate bit rate.
4. The primary channel retunes to the alternate bit rate if lock is achieved on the background channel (with acceptable station health and WER).
5. The background channel continually searches for a closer station using the station database once a lock is achieved on the primary channel.
6. The primary channel will remain tuned to the same station unless one of the following occurs:
 - Word error rate (WER) drops below 10%
 - Station becomes unhealthy or unmonitored
 - Background channel finds a closer station
 - Position changes enough to affect station list

- **Performance in Database Mode**

In most installations, Database mode will result in faster initial acquisition and better GPS accuracy compared to Auto Mode. In some installations, Database Mode may not work as well as Auto Mode for the following reasons:

1. The closest station is not in the station database and the SXblue II-B GPS has not yet received a Type7 Almanac message. Most stations now broadcast the Almanac message every 10 minutes. Assuming the SXblue II-B GPS can tune to a surrounding station and receive a Type7 message, it will update the station database and automatically retune to the closest station.
2. Signal quality in the area is poor. IEC61108-4 requires the receiver to switch away from a station when WER rises above 10%. For installations that don't need to comply with IEC61108-4, this threshold can be increased as usable corrections can be obtained for word error rates up to 50%.

3.3.4 Evaluating Performance

The SXblue II-B GPS calculates a Signal to Noise Ratio (SNR), measured in dB (Decibels), which indicates the receiver's performance. The SNR is height of the signal above the noise floor. The higher the SNR, the better the internal beacon receiver is demodulating the signal. By monitoring the SNR, you can determine the

optimum location with respect to beacon reception. The SNR is available in the \$CRMSS and \$PCSI,1 NMEA messages described in the Technical Reference Manual.

The SNR is also a function of the installation, as it may differ between locations, depending on the amount of local noise at each. The optimum antenna location will be the position where your average SNR is highest. You should turn on all accessories that you intend to use during normal operation to test the installation. If noise is affecting performance, try to find a better location with higher SNR.

Table 3-1 below describes the general quality of reception as measured by the SNR reading of the SXblue II-B GPS.

Table 3-1 SXblue II-B GPS Performance – SNR Reading

SNR	Reception Quality	Data Throughput
> 25	Excellent	100%
20 to 25	Very Good	100%
15 to 20	Good	Good (up to 100%)
10 to 15	Stable	Moderate to Good
7 to 10	Intermittent	Low
< 7	No Lock	No data throughput

4. Troubleshooting

4.1 Troubleshooting Checklist

Use the following checklist to troubleshoot anomalous SXblue system operation. The following table provides a problem symptom, followed by a list of possible solutions.

Table 4-1 Troubleshooting

Symptom	Possible Solution
Receiver fails to power	<ul style="list-style-type: none"> Recharge battery pack and try again after 15 minutes of charge Verify contact modules between battery pack and receiver Verify gasket around receiver's battery contact module
No data or position from SXblue	<ul style="list-style-type: none"> Check receiver power status and/or battery pack Verify that the receiver is configured to output data messages on the port you are communicating with (you may use SXblue Config application) Verify that SXblue is locked to a valid DGPS signal (this can often be done on the receiving device or with the use of SXblue Config application) Verify that SXblue locked to GPS satellites (this can often be done on the receiving device or with the use of SXblue Config application) Check integrity and connectivity of data cable connections
Random data from SXblue	<ul style="list-style-type: none"> Verify that the RTCM or Binary messages are not being output accidentally (send a \$JSHOW command to view the configuration of the receiver and the messages configured for output) Verify that baud rate settings of SXblue and remote device match correctly. Bluetooth (PortA) must be set to 115200 baud on the receiver Potentially, the volume of data requested to be output by the SXblue could be higher than the current baud rate supports. Try using a higher baud rate on the RS-232 and USB ports.
No GPS lock	<ul style="list-style-type: none"> Check integrity of antenna cable Verify antenna's unobstructed view of the sky Verify the lock status of GPS satellites (this can often be done on the receiving device or with the use of SXblue Config application)
No SBAS lock	<ul style="list-style-type: none"> Check antenna connections Verify antenna's unobstructed view of the sky. If starting the receiver under dense forest canopy, move the antenna location a bit until the DIFFerential LED (yellow) illuminates. See section 1.4.3.2 for field data collection guidelines Verify the lock status of SBAS satellites (this can often be done on the receiving device or with the use of SXblue Config application) Verify that SBAS satellite PRN numbers being searched by the receiver are the proper ones (WAAS, EGNOS, MSAS, GAGAN, etc). This may be verified with the \$JWAASPRN command. See Appendix C for a list of PRN numbers for the various active SBAS constellations
No DGPS position in external RTCM mode	<ul style="list-style-type: none"> Verify that the baud rate of the RTCM input port matches the baud rate of the external source Verify the pin-out between the RTCM source and the RTCM input port (transmit from the source must go to receive of the RTCM input port and grounds must be connected - Refer to Appendix A)
Non-differential GPS output	<ul style="list-style-type: none"> Verify the SXblue SBAS and lock status (or if external source is locked)

4.2 Using the LEDs to Troubleshoot

The SXblue receiver has 5 LED indicator lights that serve as status indicators. The first 4 lights should all be illuminated solid (non-blinking) when the receiver is powered on and has a valid GPS and differential solution. The last LED (furthest to the right) should only be illuminated solid if you are connected using Bluetooth communications. Otherwise, the lights can be in various states (blinking, on solid, or off). Table 4-2 describes the LED lights operation.

Table 4-2 LED Functions

	<p>Power LED: (Red)</p> <p>This LED should be on (solid) once power is applied to the receiver. This is the only LED that is not under GPS computer control. Once the battery voltage reaches a certain threshold, this LED will start blinking (roughly 15-20 minutes prior to auto shutdown).</p>
	<p>GPS LED: (Green)</p> <p>This LED serves two purposes: At power-on if it starts blinking, the GPS processor is likely faulty. After a minute or so, this LED should go on solid green to indicate that GPS has locked. This is true even if differential corrections are not available. If the LED is continually blinking and you have been programming your SXblue, it is possible it is still in programming mode. The SXblue will not communicate while in this state. Simply power cycle the SXblue to restore normal communications.</p>
	<p>DGPS LED: (Orange)</p> <p>This LED will remain off until a differentially corrected GPS solution is available. It will blink at a steady rate if the solution has not converged to the accuracy specified by the \$JLIMIT command and will become solid yellow after the solution has converged. (The \$JLIMIT sets the threshold for the RMS residual error and this error gives a rough indication of expected user accuracy. Note, however, that it is not a direct measure of accuracy. Factors such as constellation geometry must also be taken into account. The default value for \$JLIMIT is 10 meters). It will also blink if the solution is a 2D solution (see the \$JALT command).</p>
	<p>Differential Source LED: (Yellow)</p> <p>This LED can be in several states: Off – Differential signal has not been received. Flickering on and off – the receiver is close to acquiring the differential signal. Blinking at a steady rate - Differential signal has been acquired, but the Bit-Error-Rate (BER) of the “best” signal tracked is higher than 150. Generally, this will not affect performance, but it is a warning of weak signal strength. On Solid – WAAS, Atlas, Radio Beacon or external differential correction has been acquired and signal strength is good.</p>
	<p>Bluetooth LED: (Blue)</p> <p>This LED will remain off until a Bluetooth connection is established between the SXblue and the other device. It will remain on until the connection is broken.</p>

Appendices

Appendix A - Interface

This appendix provides information on interfacing the main aspects of your SXblue receiver.

The main purpose of the SXblue is to provide differentially corrected position and related information to a data logging or navigation device in the standard NMEA format. In addition to the SXblue receiver as a positioning sensor, you may also have a use for the correction data received by the internal SBAS demodulator.

The following sections detail how to interface your SXblue depending on your application.

GPS NMEA Output

When operating the SXblue receiver as a differential positioning tool, the data output from either SXblue communication port (Serial, USB or Bluetooth) is NMEA data that provides a variety of information, such as position, speed, satellites tracked, and more. This is the normal (default) data output and mode of operating the SXblue receiver.

To establish communications between the SXblue receiver and your data logging or navigation device in this mode of operation, you must:

- Connect Pin-2 - transmit (TX) of the supplied SXblue Serial cable to the receive pin (RX) of the data logging or navigation device.
- Connect Pin-3 - receive (RX) of the SXblue Serial cable to transmit pin (TX) of the other device if it is able to configure the SXBlue receiver. Otherwise, this connection is optional.
- Connect Pin-5 - signal ground of the SXblue Serial Port to the signal return or ground of the external device.

Figure A-1 illustrates the required interface between the SXblue receiver and an external device using the serial cable:

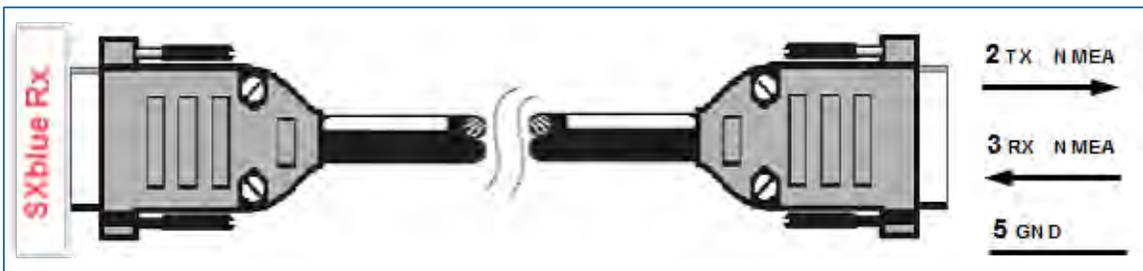

Figure A-1 Serial Interface

Note - For successful communication, the baud rate of the SXblue port must be set to match that of the data logging or monitoring device. The SXblue receiver only supports an RS-232C voltage level serial port. Refer to Technical Reference Manual for instructions related to setting the SXblue baud rate with the \$JBAUD command.

External Correction Input

In this operating mode, an external correction device inputs RTCM correction data through the Serial port. In order to accomplish this, the SXblue receiver must be commanded to use external corrections using both RX Config and Serial Port (B) tab of the SXblue Config application.

To configure external correction input on the Serial port you must:

- Communicate with the SXblue on the Serial Port (B). Ensure that the baud rate of the Serial Port and the external correction source match.

To establish communications between the SXblue receiver and an external differential correction source, you must:

- Connect Pin-3-receive (RX) of the serial cable to transmit pin (TX) of the external correction source
- Connect Pin-5-Common Ground of the serial cable to the signal return or common ground of the external correction source

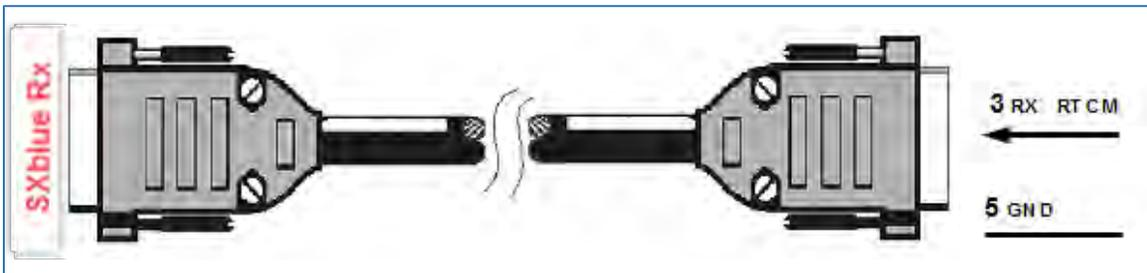

Figure A-2 RTCM Data Input to Serial Port

Note - For successful communications, the baud rate of the SXblue differential port must be set to match that of the external correction source. The correction source must support an RS-232 interface level and the baud rates between each device must match. Refer to Technical Reference Manual for instructions related to setting the SXblue baud rate using the \$JBAUD command.

Appendix B - Introduction to GNSS and DGPS Services

This chapter provides a brief overview of GPS, differential GPS, Space Based Augmentation Systems (SBAS) such as WAAS / EGNOS / MSAS / GAGAN.

GPS

The United States Department of Defense (DoD) operates a reliable, 24 hour a day, all weather Global Positioning System (GPS).

Navstar, the original name given to this geographic positioning and navigation tool, includes an official constellation of 24 satellites (plus active spares) orbiting the Earth at an altitude of approximately 22,000 km.

How it Works

These satellites transmit coded information to GPS users at UHF (1.575 GHz) frequencies that allows user equipment to calculate a range to each satellite. GPS is essentially a timing system - ranges are calculated by timing how long it takes for the coded GPS signal to reach the user's GPS antenna.

To calculate a geographic position, the GPS receiver uses a complex algorithm incorporating satellite coordinates and ranges to each satellite. Reception of any four or more of these signals allows a GPS receiver to compute 3D coordinates. Tracking of only three satellites reduces the position fix to 2D coordinates (horizontal with fixed vertical).

The GPS receiver calculates its position with respect to the phase center of the GPS antenna. The latitude, longitude, and altitude of the antenna are referenced according to the current version of the World Geodetic System 1984 ellipsoid (WGS-84). At the time of print, the current WGS-84 version is G1150 and follows the ITRF 2000 datum (International Terrestrial Reference Frame)

GPS Services

The positioning accuracy offered by GPS varies depending upon the type of service and equipment available. For security reasons, two GPS services exist: the Standard Positioning Service (SPS) and the Precise Positioning Service (PPS). The SPS uses a code modulated onto the signal for measurements and is referred to as the Coarse Acquisition code (C/A code). The US Department of Defense (DoD) reserves the PPS for use by its personnel and authorized partners. The PPS uses a different code than the SPS, referred to as the Precise Code (P-code) and contains more resolution than the C/A code. The DoD provides the SPS free of charge, worldwide, to all civilian users.

In order to maintain a strategic advantage, the US DoD used to artificially degrade the performance of the SPS so that the positioning accuracy was limited to 100 meters 95% of the time. This intentional degradation was called Selective Availability (SA). The effect of SA has been turned to zero since mid-2000, and has been officially ‘turned off’ since then (2007).

Currently, autonomous GPS is able to provide accuracy on the order of 10 meters, depending on the sophistication of the GPS engine. For many positioning and navigation applications, this level of accuracy is not sufficient, and differential techniques must be employed.

Differential GPS

The primary sources of errors that degrade GPS performance include SA (currently set to a zero effect), atmospheric errors, timing errors, satellite orbit errors, and multipath. Differential GPS (DGPS) is essentially a differencing process that removes sources of error from the GPS position solution and improves the integrity of the GPS position solution. There are a number of methods of differential measurement correction:

- Conventional real-time differential – This is the most common form of correcting GPS errors in real-time with corrections sent to the rover GPS receiver by some form of communications equipment. Conventional real-time differential uses C/A code range measurements and their associated corrections. Carrier phase corrections are not used with this form of differential technique.
- Post processing – This method is often used when either higher accuracy than achievable through conventional differential is needed, or a conventional form of real-time corrections is not available in the region where the rover receiver is being operated. Depending on receiver hardware and the methodology used for post process, performance can be from many centimeters to millimeter precision. A variety of 3rd party software packages are available to post process GPS raw measurement data. The SXblue receiver can be configured to output raw measurement data at rates of up to 20 Hz in a proprietary format. This data can be converted to an industry standard RINEX format if needed.
- Real-Time Kinematic – This method uses more sophisticated techniques to resolve the number of wavelengths between the satellite and the user, to provide centimeter-level positioning (or better) in real-time. This technique uses high-end receiver hardware, antennas, and internal operating software to compute accurate position solutions. The compromise with this method of differential correction is increased system complexity, cost, and operating constraints.

The SXblue receiver includes a primary source of conventional real-time corrections –Space-Based Augmentation System (SBAS). External corrections may also be input to the SXblue receiver for situations where either internal correction services is not available or an external source is preferential.

In addition to the conventional differential positioning with internal sources of corrections, the SXblue receiver also has a documented binary raw measurement protocol. A RINEX translator is available from SXblue GPS in the event that this may be useful, in addition to some C code snippets to aid in integrating the binary format itself into your own application.

The SXblue receiver also uses an RTK solution option which allows cm level field data collection, precise guidance and stake-out applications.

Conventional Real-Time Differential

The majority of GPS navigation and positioning uses this form of positioning. Conventional real-time differential techniques are more robust in their usage and versatility than post-processing or RTK solutions. They are tolerant to errors in communication of the real-time corrections from the base station or correction network, provide a reasonable amount of accuracy (sub-meter accuracy is best-case), and can be simply turned on and used without too much regard other than ensuring a lock to GPS satellite signals and the correction communication link.

How it Works

Conventional DGPS involves setting up a reference GPS receiver at a point of known coordinates. This receiver makes distance measurements, in real-time, to each of the GPS satellites. The measured ranges include the errors present in the system. The base station receiver calculates what the true range, without errors, knowing its coordinates and those of each satellite. The difference between the known and measured range for each satellite is the range error. This error is the amount that needs to be removed from each satellite distance measurement in order to correct for errors present in the system.

The base station transmits the range error corrections to remote receivers in real-time. The remote receiver corrects its satellite range measurements using these differential corrections, yielding a much more accurate position. This is the predominant DGPS strategy used for a majority of real-time applications. Positioning using corrections generated by DGPS radiobeacons will provide a horizontal accuracy of 1 to 5 meters with a 95% confidence. More sophisticated, short-range DGPS systems (10 to 15 km) can achieve centimeter-level accuracy, but are expensive and often limited to precise survey applications due to technical constraints on their use.

DGPS Format

For manufacturers of GPS equipment, commonality is essential to maximize the utility and compatibility of a product. The governing standard associated with GPS is the Interface Control Document, ICD-GPS-200, maintained by the US DoD. This document provides the message and signal structure information required to access GPS.

Like GPS, DGPS data and broadcast standards exist to ensure compatibility between DGPS services and associated hardware and software. The Radio Technical Commission for Maritime Services Special Committee 104 has developed the primary DGPS standard associated with conventional DGPS, designated RTCM SC-104 V2.2. This correction standard is used by many

correction services, including many private reference stations and DGPS beacon systems. The SXblue receiver supports this correction protocol via either of its communication ports.

In addition to the RTCM standard, the Radio Technical Commission for Aeronautics has a differential service intended for wide area correction services, designated RTCM SC-159. The United States Federal Aviation Administration's Wide Area Augmentation System (WAAS) and other compatible Space Based Augmentation Systems (SBAS) such as the European Geostationary Navigation Overlay System (EGNOS), the Japanese MT-SAT Satellite-based Augmentation System (MSAS) and the Indian Space Research Organization's GPS Aided Geo-Augmented Navigation system (GAGAN) system use this data format. The SXblue receiver is compatible with each of these differential services.

Note – When using a differential correction service, the resultant position may be referenced to a local datum rather than the current WGS-84 ellipsoid. Please refer to your signal provider for more information.

Post Processing

Post processing is a method to compute accurate positions in post mission by logging raw measurement data at the base station and the rover simultaneously. The differential processing can then be performed later in the office using sophisticated processing software tools. There are a small variety of methodologies available to the operator, such as static, rapid static, kinematic, etc.

Describing in detail the various post processing techniques is beyond the scope of this document, however, generally, post processing is more complicated from a procedural perspective and requires more skill to successfully operate than real-time systems.

Factors Affecting DGPS Accuracy

Many factors affect the positioning accuracy that a user may expect from a DGPS system. The most significant of these influences include:

- Proximity of the remote user to the reference station (atmospheric and orbit errors)
- Age of the received differential corrections
- Atmospheric conditions at the beacon and remote user locations
- Satellite constellation geometry, often expressed as a Dilution of Precision (DOP)
- Magnitude of GPS signal multipath present at the remote station
- Quality of the GPS receiver being used at both the reference and remote stations

Proximity of the Reference Station

The distance between a remote user and the reference station can sometimes be

considerable, such as when using 300 kHz DGPS radiobeacons. Consequently, some of the errors associated with GPS at the base station differ somewhat from those at the remote user's location. This spatial decorrelation of errors can result in a relative position offset from the absolute coordinates of the remote receiver. This offset may be as much as one meter for every 100 km (62 miles) between the base station and remote receiver.

The causes of decorrelation are:

- GPS satellite orbit errors (significant)
- Ionospheric errors (potential to be most significant depending on level of activity)
- Tropospheric errors (less significant)

GPS satellite orbit errors are typically a greater problem with local area differential systems. The decorrelation effect is such that the satellite's orbit error projects onto the reference receiver and remote receiver's range measurements differently. As the separation between the receivers increases, the orbit error will not project onto the ranges in the same manner, and will then not cancel out of the measurement differencing process completely. SBAS networks, with the use of multiple base stations, are able to accurately compute the orbit vector of each satellite. The resulting corrector is geographically independent, so minimal decorrelation occurs with respect to position within the network.

The ionosphere and the troposphere both induce measurement errors on the signals being received from GPS. The troposphere is the humid portion of the atmosphere closest to the ground. Due to its humidity, refraction of GPS signals at lower elevations can distort the measurements to satellites. This error source is rather easily modeled within the GPS receiver and doesn't constitute a significant problem.

The error induced by the ionosphere is more significant, however, and is not as simple a task to correct. The ionosphere is the charged layer of the atmosphere responsible for the Northern Lights. Charged particles are ionized by solar radiation resulting in an electrically active atmospheric layer. This charged activity affects the GPS signals that penetrate this layer, affecting the measured ranges. The difficulty in removing the effect of the ionosphere is that it varies from day to day, and even hour to hour due to the sun's 11-year solar cycle and the rotation of the earth, respectively. During the summer of 2001, the sun's solar cycle reached an 11-year high and going forward we saw a general cooling trend of the ionosphere over the few years that followed, thus with reduced ionospheric activity.

Removing the effect of the ionosphere depends on the architecture of the differential network. DGPS radiobeacons, for example, use a more conventional approach than WAAS or SBAS in general. DGPS beacons make use of a single reference station, which provides real-time GPS error corrections based upon measurements that it makes at its location. It is possible that the state of the ionosphere differs between the remote user and the single reference station. This

can lead to an incompletely corrected error source that could degrade positioning accuracy with increased distance from the base station.

SBAS systems (WAAS, EGNOS, MSAS, GAGAN, etc) use a different approach, using a network of reference stations in strategic locations to take measurements and model the real-time ionosphere. Updates of the ionospheric map are sent on a continual basis to ensure that as the activity of the ionosphere changes with time, the user's positioning accuracy will be maintained. Compared to using a DGPS beacon, the effect of geographic proximity to a single reference station is minimized resulting in more consistent system performance throughout all locations within the network.

Correction Latency

The latency of differential corrections to a lesser extent affects the achievable positioning accuracy at the remote receiver since the magnitude of SA was turned to zero in year 2000. Latency is a function of the following:

- The time it takes the base station to calculate corrections
- The data rate of the radio link
- The time it takes the signal to reach the user
- The time required for the remote differential receiver to demodulate the signal and communicate it to the GPS receiver.
- Any data loss that occurs through reception problems

Most of these delays require less than a second, though in some instances, depending upon the amount of information being transferred, overall delays of three to five seconds may occur. The effect of latency is mitigated by the COAST technology within the SXblue receiver. This technology is especially valuable in conditions of DGPS signal loss where the age of corrections increases for each second of signal loss. See Section 2.6 for further information on COAST.

Satellite Constellation Geometry

The number of satellites visible and their geometry in the sky influences positioning accuracy. The Dilution of Precision (DOP) describes the strength of location and number of satellites in view of the receiver. A low DOP indicates a strong potential for better accuracy than a high DOP. Generally, more satellites visible to both the reference and remote receivers will provide a lower DOP (any satellites seen by one receiver and not the other, are not used in the position solution). Additionally, if the satellites are evenly spread around the receiver, rather than grouped in a few regions of the sky, a lower DOP (stronger solution) will result.

GPS Signal Multipath

Satellite signals received from reflective object nearby the working area by the GPS receiver can decrease positioning accuracy. These multipath signals increase the measured range to a satellite as the signal takes a longer route to the

GPS antenna. Certain precautions will minimize GPS antenna sensitivity to these reflected signals. Operating away from large reflective structures such as buildings or using special antennas and GPS equipment can help to reduce the impact of multipath. For most consumer-level applications, a small amount of multipath is tolerable.

GPS Receiver Quality

The quality of a GPS receiver has a dramatic influence on positioning accuracy. Consumer-based GPS products, such as many affordable handheld and fixed-mount receivers, typically operate with an accuracy of 3 to 5 meters horizontally 95% of the time. The accuracy of a particular product depends on the specific receiver's performance characteristics. Higher accuracy GPS receivers are able to achieve sub-1 meter horizontal accuracy 95% of the time using real-time DGPS transmissions. The SXblue receiver falls into this latter category.

Space Based Augmentation Systems (SBAS)

The US Federal Aviation Administration has developed a Wide Area Augmentation System (WAAS) for the purpose of providing accurate positioning to the aviation industry. In addition to providing a high quality and accurate service for this industry, this service is available free of charge to all other civilian users and markets in Central and North America. This service falls into the greater category of Space Based Augmentation System (SBAS).

Upon the successful completion of a 21-day test on August 24, 2000, the Federal Aviation Administration of the United States of America announced that its Wide Area Augmentation System (**WAAS**) would be running 24 hours per day, seven days per week from then on. Testing has shown since that this signal is accurate and reliable. Since the date it was commissioned (July 10, 2003), WAAS has undergone a few changes in its satellite constellation and coverage (PRN 122 and 134 phased out and replaced by PRN 135 and 138 at new locations; and with the addition of ground monitoring stations in Canada and Mexico in September 2007). In summer 2010, PRN 133 has been added to the constellation and in late December 2010, PRN 135 was recovered after being out of control for a few months, bringing the total number of operational satellites to three.

Other government agencies have followed the pace and developed compatible SBAS systems for their respective geographic regions. In Europe, the European Space Agency, the European Commission, and EUROCONTROL have jointly developed the European Geostationary Overlay System (**EGNOS**). EGNOS is now fully deployed and in its pre-operational phase. The system will undergo certification for safety-of-life applications before becoming fully operational. Furthermore, on June 28, 2007, the European Space Agency and the Agency for Security of Air Navigation in Africa and Madagascar have signed a cooperation agreement with the objective of using satellite navigation to improve air traffic safety over the African continent.

In Japan, the MTSAT Satellite-based Augmentation System (**MSAS**) has been deployed by the Japan Civil Aviation Bureau (JCAB). Successful launches of MTSAT-1R and MTSAT-2 were followed by system integration for MSAS ground system and MTSATs by transmitting test signal from MTSATs. Purposes of test signal transmission were to optimize system performance and then to verify that augmentation information meets safety and performance requirements. Since those tests had been accomplished successfully, MSAS for aviation use was commissioned on September 27, 2007.

In India, the Indian Space Research Organisation and Airports Authority of India have successfully completed the final system acceptance test of the GPS Aided GEO Augmented Navigation system (**GAGAN**) as announced on November 20, 2007 by Raytheon Company. With completion of the final system acceptance test, the stage is set for India to embark on the next phase of the program, which will expand the existing ground network, add redundancy, and produce the certification analysis and documentation for safety-of-flight commissioning. The launch of their own communication satellites is scheduled for May 11, 2011. Note that GAGAN is no longer broadcasting on Inmarsat 4f1.

China has a similar program for a SBAS and the service is named the Chinese Satellite Navigation Augmentation System (**SNAS**).

The SXblue receiver is capable of receiving correction data from all compatible SBAS.

Warning – Use of non-commissioned SBAS signals is entirely at your risk and discretion.

How it Works

A SBAS incorporates a modular architecture, similar to GPS, comprised of a Ground Segment, Space Segment, and User Segment:

- The Ground Segment includes reference stations, processing centers, a communication network, and Navigation Land Earth Stations (NELS)
- The Space Segment includes geostationary satellites (For example, EGNOS uses Inmarsat transponders).
- The user segment consists of the user equipment, such as a SXblue receiver and antenna

A SBAS uses a state-based approach in their software architecture. This means that a separate correction is made available for each error source rather than the sum effect of errors on the user equipment's range measurements. This more effectively manages the issue of spatial decorrelation than some other techniques, resulting in a more consistent system performance regardless of geographic location with respect to reference stations. Specifically, SBAS calculates separate errors for the following:

- The ionospheric error

- GPS satellite timing errors
- GPS satellite orbit errors

Figures B-1 and B-2 show the ground segments of the WAAS and EGNOS systems, respectively. In 2007, a total of 13 monitoring stations have been added to the existing WAAS network, increasing the ionospheric coverage for this SBAS constellation. The location is shown in red in Figure B-1: 4 in Alaska, 4 in Canada and 5 in Mexico.

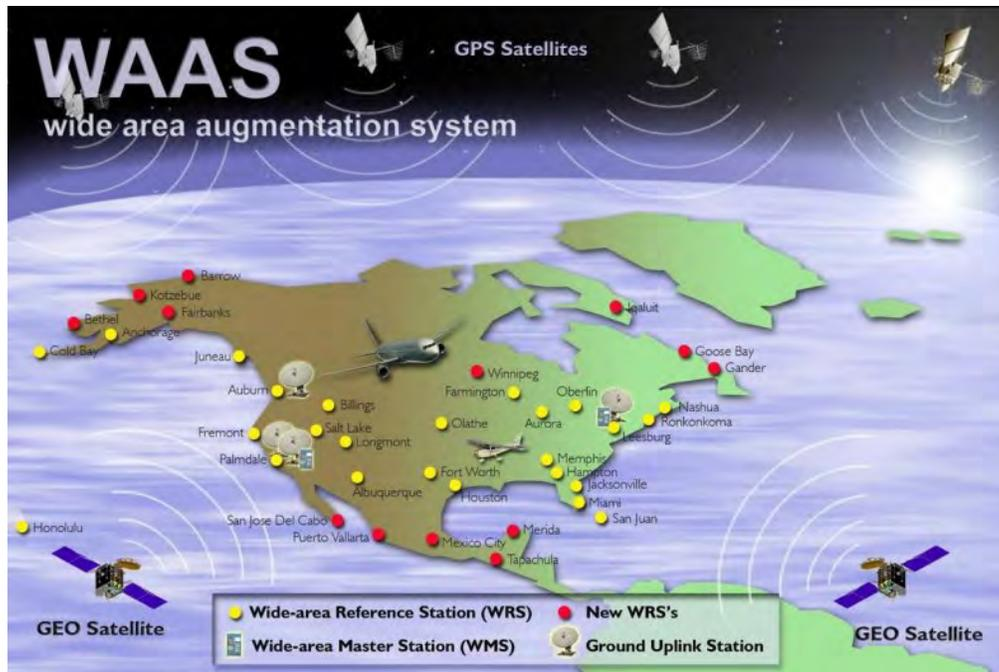

Figure B-1 WAAS Ground Segment (end of 2007)

Provided that a GPS satellite is available to the SBAS reference station network for tracking purposes, orbit and timing error corrections will be available for that satellite. Ionospheric corrections for that satellite are only available if the signal passes through the ionospheric map provided by SBAS (ex. the WAAS ionospheric map covers the entire Central and North American region). As an example, if a satellite is South of your current location at a low elevation angle, the pierce point of the ionosphere will be considerably South of your location since the ionosphere is at an altitude of approximately 60 km. There must be sufficient ionospheric map coverage beyond your location in order to have ionospheric correctors for all satellites.

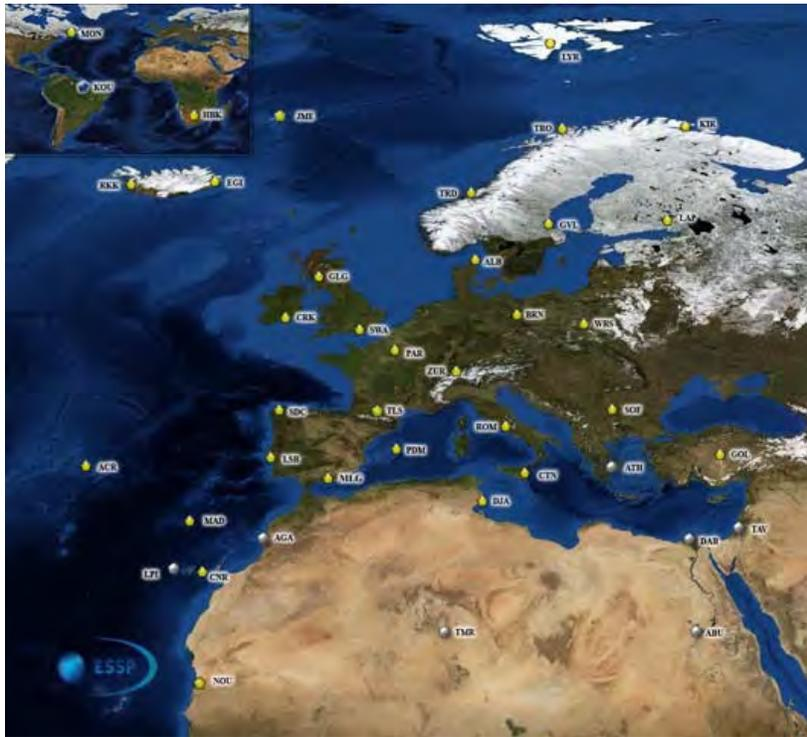

Figure B-2 EGNOS Ground Segment (2010)

To enhance the information provided by SBAS, the SXblue receiver has a unique ability to extrapolate the ionospheric information beyond the broadcast information. This feature increases the usable geographic coverage area of a SBAS system.

Signal Information

A SBAS transmits correction data on the same frequency as GPS from a geostationary satellite (the space segment), allowing the use of the same receiver equipment used for GPS. Another advantage of having SBAS transmit on the same frequency is that only one antenna is required.

Reception

Since SBAS broadcast in the L-band, the signal requires a line of sight in the same manner as GPS to maintain signal acquisition. Let's select WAAS for an example. Currently, two communication satellites are transmitting WAAS data for public use. Due to their location, these satellites may appear lower on the horizon, depending on your geographic position on land. In regions where the satellites appear lower on the horizon, they may be more prone to being masked by terrain, foliage, buildings or objects, resulting in signal loss. The further that you are away from the equator and the satellite's longitude will cause the satellite to appear lower on

the horizon. Fortunately, the COAST Technology helps alleviate this problem by maintaining system performance when SBAS signal loss occurs for extended periods of time. More information on COAST is provided in Section 2.6.

When using SBAS correction data, the SXblue receiver is able to provide you with the azimuth and elevation of the SBAS available satellites via a NMEA command to aid in determining their position with respect to the built-in antenna. See the Technical Reference Manual for more information on the \$JGEO command.

Worldwide SBAS Coverage

Figure B-3 depicts the current world SBAS coverage. This figure is only an approximation of signal coverage by each of the SBAS constellation. Although there is geographic coverage at higher latitudes, practical usage of SBAS will be limited to environments where a relatively consistent line of sight to the satellites from the SXblue receiver is available.

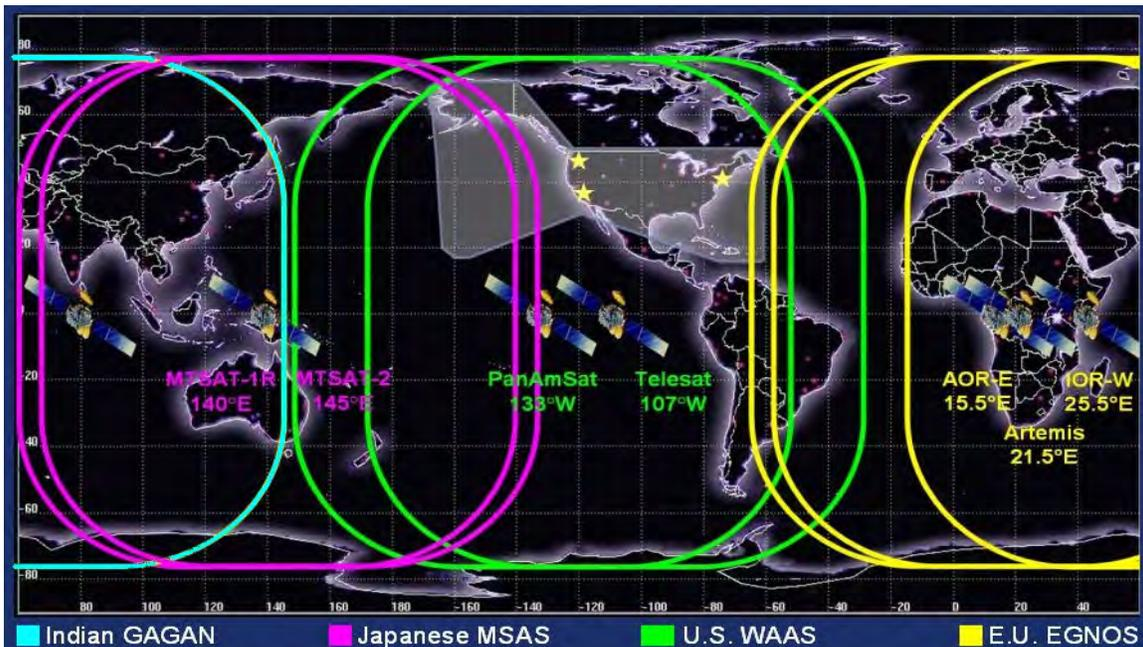

Figure B-3 Worldwide SBAS Coverage

Table B-1 lists all the PRN numbers allocated to each of the SBAS Constellations.

Figure B-4 shows the ionospheric coverage for each of the SBAS constellations. For WAAS, EGNOS, MSAS and GAGAN the grids shown are actual typical grids recorded with an SXblue receiver (with no extrapolation).

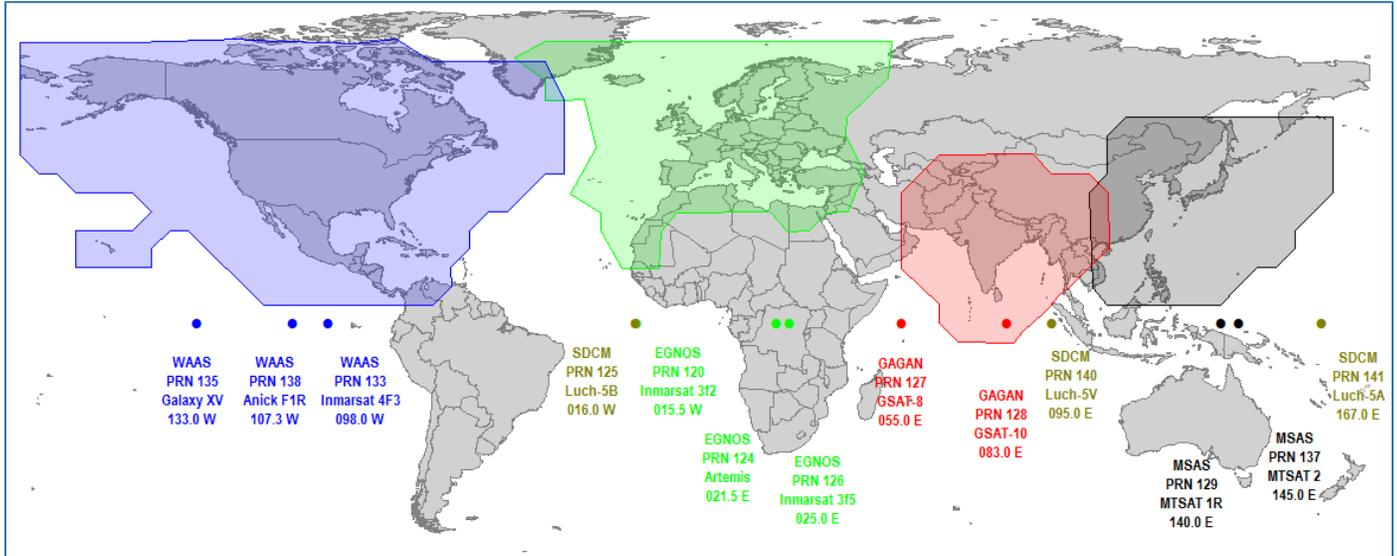

Figure B-4 Worldwide SBAS Ionospheric Coverage

Table B-1 Worldwide SBAS Constellation (December 2012)

SBAS Constellation	PRN Number	NMEA Number	Satellite Name	Longitude
WAAS	133	46	Inmarsat 4F3	98.0° W
WASS	135	48	Galaxy XV	133.0 W
WAAS	138	51	Anik F1R (Telesat)	107.3° W
EGNOS	120	33	Inmarsat 3F2 (AOR-E)	15.5° W
EGNOS	124	37	ESA (Artemis)*	21.5° E*
EGNOS	126	39	Inmarsat 3F5 (IND-W)	25.0° E
MSAS	129	42	MTSAT 1R	140.0° E
MSAS	137	50	MTSAT 2	145.0° E
GAGAN	127	40	GSAT-8	55.0° E
GAGAN	128	41	GSAT-10	83.0° E
SDCM	125	38	Luch-5B**	16.0° W**
SDCM	140	53	Luch-5V**	95.0° E**
SDCM	141	54	Luch-5A**	167.0° E**

* EGNOS PRN 124 normally used to perform industry tests, is currently set to test mode.

** SDCM is not operational. Luch-5B might be repositioned to a more eastern location. Luch-5A is currently at 95.0°E and will be moved to 167.0°E. Luch-5V launch is planned for Q1 2014.

Note - The satellite elevation angle lowers with increasing distance away from the equator and from the satellite's longitude. Although a good amount of signal coverage is shown in Northern latitudes for both WAAS and EGNOS, it may not be usable due to its low elevation angle and the potential for it to be obstructed. Ideally, testing of the system in the area of its use is recommended to ensure that the signal is sufficiently available.

Note - The SBAS signal coverage may be present in some areas without either sufficient ionospheric map coverage or satellites with valid orbit and clock correctors. In such a case, differential positioning with SBAS may not be desirable or possible, as four or greater satellites (with correctors) must be available to compute a DGPS position. The next section provides further information on the ionospheric map features of SBAS and the SXblue receiver.

SBAS Ionospheric Map Extrapolation

To improve upon the ionospheric map provided by SBAS, the SXblue receiver extrapolates a larger ionospheric map from the broadcast coverage map, extending its effective coverage. This allows the SXblue receiver to be used successfully in regions where competitive products may not. For example, the extrapolation provides enhanced coverage through the northern part of South America for WAAS, through the northern part of Africa for EGNOS, etc.

Please note that the process of estimating ionospheric corrections beyond the SBAS broadcast map would not be as good as having an extended SBAS map in the first place. This difference may lead to minor accuracy degradation. As an example, Figure B-5 depicts the broadcast WAAS and EGNOS ionospheric map extent and the extrapolated version. As can be seen, the extrapolated grid extends further in all directions than the broadcast one, enhancing usable coverage.

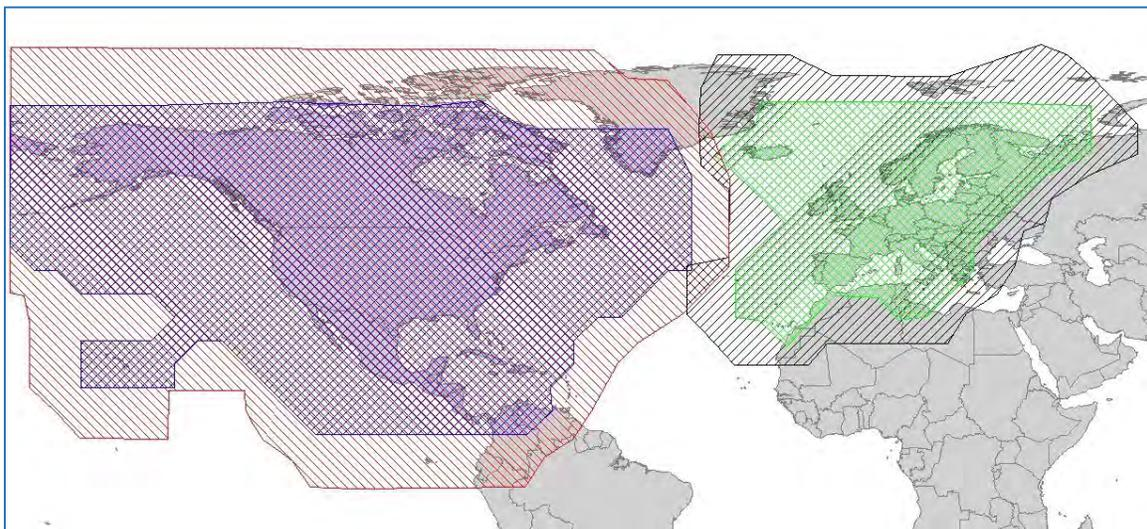

Figure B-5 Broadcast and Extrapolated Ionospheric Correction Map

Appendix C - Resources

Reference Documents

National Marine Electronics Association, National Marine Electronics Association (NMEA 0183) Standard for Interfacing Marine Electronic Devices, Version 2.1, October 15, NMEA 1995, PO Box 50040, Mobile Alabama, 36605 USA, Tel: +1-205-473-1793, Fax: +1-205-473-1669

Radio Technical Commission for Maritime Services, RTCM Recommended Standards for Differential NAVSTAR GPS Service, Version 2.2, Developed by Special Committee No. 104, RTCM 1998, 1800 Diagonal Rd, Suite 600, Alexandria, VA, 22314-2840 USA, Tel: +1-703-684-4481, Fax: +1-703-836-4429

Radio Technical Commission for Aeronautics, Minimum Operational Performance Standards (MOPS) for Global Positioning System/Wide Area Augmentation System Airborne Equipment, Document RTCA DO-229A, Special Committee No. 159, RTCA 1998, 1828 L Street, NW, Suite 805, Washington, DC, 20036 USA, Tel: +1-202-833-9339

ARIC Research Corporation, Interface Control Document, Navstar GPS Space Segment / Navigation User Interfaces, ICD-GPS-200, April 12, 2000, 2250 E. Imperial Highway, Suite 450, El Segundo, CA 90245-3509, www.navcen.uscg.gov/gps/geninfo/default.htm

SXblue GPS Web Site

This following address is the SXblue GPS Web site which provides detailed information on the various receivers manufactured by SXblue GPS: www.sxbluegps.com

GPS General Resources

NAVSTAR GPS Joint Program Office: <http://www.losangeles.af.mil/library/factsheets/factsheet.asp?id=5311>

US Coast Guard Navigation Center: <http://www.navcen.uscg.gov>

FAA WAAS Web Site

This site offers general information on the WAAS service provided by the U.S. FAA.

http://www.faa.gov/airports_airtraffic/technology/waas/

GNSS Services:

http://www.faa.gov/about/office_org/headquarters_offices/ato/service_units/techops/navservices/gnss/

For realtime WAAS satellite corrections and performance:

<http://www.nstb.tc.faa.gov/index.htm>

To subscribe to the SatNav newsletter notification:

<http://www.faa.gov/help/subscribe/>

ESA EGNOS Web Site

This site contains information relating to past performance, real-time performance, and broadcast schedule of EGNOS.

ESA main page: <http://www.esa.int/esaCP/index.html>

EGNOS User Support:

http://egnos-user-support.essp-sas.eu/egnos_ops/index.php

EGNOS for Professionals: <http://www.egnos-pro.esa.int/index.html>

MSAS Information

Kobe Aeronautical Satellite Center in Japan provides some info on MSAS on the following page: <http://www.kasc.go.jp/english/index.htm>

International Association of Marine Aids to Navigation and Lighthouse Authorities (IALA)

<http://www.iala-aism.org/>

Atlas Web Site

<https://www.atlasgnss.com/>

Finding Satellite Elevations

The following web page allows computing elevations of satellites above horizon from any location in the world: <http://www.lyngsat.com/> (Java in browser should be enabled)

WAAS PRN 133: <http://www.lyngsat.com/tracker/galaxy19.html> (same location as...)

WAAS PRN 135: <http://www.lyngsat.com/tracker/galaxy12.html> (same location as...)

WAAS PRN 138: <http://www.lyngsat.com/tracker/anikf1r.html>

EGNOS PRN 120: <http://www.lyngsat.com/tracker/inmar3f2.html>

EGNOS PRN 126: <http://www.lyngsat.com/tracker/inmar3f5.html> (same location as...)

EGNOS PRN 124: <http://www.lyngsat.com/tracker/artemis.html>

MSAS PRN 129: <http://www.lyngsat.com/tracker/mts1r.html>

MSAS PRN 137: <http://www.lyngsat.com/tracker/mts2.html>

GAGAN PRN 128: <http://www.lyngsat.com/tracker/in4a.html> (same location as...)

Datum Information

Canadian Geodetic Reference Systems:

<http://www.nrcan.gc.ca/earth-sciences/geomatics/geodetic-reference-systems/18766>

US National Geodetic Survey FAQ's: <http://www.ngs.noaa.gov/faq.shtml>

Online HTDP Reference Frame Transformation tool:

<http://www.ngs.noaa.gov/cgi-bin/HTDP/htdp.prl?f1=4&f2=1>

Solar and Ionospheric Activity Web Sites

The following sites are useful in providing details regarding solar and ionospheric activity:

<http://iono.jpl.nasa.gov/index.html>

<http://www.spaceweather.com>

<http://www.n3kl.org/sun/noaa.html>

GPS, GIS and Survey Related Magazines

GPSWorld Magazine: <http://www.gpsworld.com/>

GPSWorld Survey/Construction News: <http://sc.gpsworld.com/gpssc/>

GIM International: <http://www.gim-international.com/>

POB Magazine: <http://www.pobonline.com/>

Direction Magazine: <http://www.directionsmag.com/>

GeoWorld: <http://www.geoplace.com>

Geoconnexion International Magazine: <http://www.geoconnexion.com/>

Index

5

5V PWR, 64
5Volt DC Output (PWR), 65

A

Accuracy, 46, 89, 91
Applications
 activating, 74

B

Battery
 charger, 18
 contact, 17
 fuel gauge, 17
 pack, 17
Baud Rate, 64, 85
Binary, 62, 67
Bit Error Rate (WAAS), 48
Bluetooth, 63
Bluetooth Communication, 22
Bluetooth Connectivity, 63

C

Carrying Case, 32
COAST Feature, 54, 57
Communication, 62
Connectivity, 63, 84, 85
Customer Service, xiii

D

Default Application, 20
Default GPS NMEA Message
 Output, 21
Default Parameters, 20, 22
Default Port Settings, 21
DGPS Errors, 89
 Age of Correction, 91
 Geometry, 91
 Latency, 91
 Multipath, 91

Proximity, 89
Differential Corrections, 88
Differential GPS (DGPS), 88

E

EGNOS, 92
Event Marker, 64
Event Marker Input (EM), 65

F

Features, 46
Field Data Collection
 configuration, 40
 guidelines, 41

G

GAGAN, 93
SXblue GPS EZSurv, 45
GPS, 88
GPS Performance, 60

H

Humidity, 65

I

ICD-GPS-200, 88
Installation
 Connecting to External Devices, 63
 Environmental Considerations, 65
 Placement, 62
Interface, 62, 84
Ionospheric Map, 98

L

LED, 80
LED Indicators
 definition, 38
Local-Dif, 59
Local-RTK, 59

M

MSAS, 93
Multipath, 91

N

NMEA 0183, 62, 66

O

One Pulse per Second (1PPS), 64

P

Performance, 46
Post Processing, 59
Precision Antenna, 18

R

Real-Time Differential Options, 58
RINEX Converter, 45
RTCM SC-104, 67, 88

S

SBAS, 47, 86, 92
SBAS Coverage, 96
SBAS Performance, 48
Selective Availability (SA), 87

Serial Port, 63
Setting up for Submeter Work, 32
SNAS, 93
SXBlue Config, 44
SXBlue Mirror, 44
SXBlue RTN, 44
SXBlue Server, 44
System Overview, 16

T

Temperature, 65
Troubleshooting, 80
Tune Mode
 WAAS Automatic Tracking, 48

U

Update Rates, 47
USB, 63
USB Drivers, 30
Using the Sofhat, 33

W

WAAS, 92
 Bit Error Rate, 48
 Receiver Performance, 48
WGS-84, 86

Revision history:

Rev 1.1 March 2008

- Updated SBAS information in Appendix C

Rev 1.2 November 2008

- Section 4.6 updated with proper Auto-Dif command sets
- Updated GAGAN information in Appendix C
- New default Baud rate for Bluetooth now set to 57600 (sec 1.3.1, 1.4.3.1, 4.2.7, 4.3.6, 6.4)
- Update datum info SBAS to use updated ITRF2000 (sec 1.4.3.1)
- Update RTK commands. Add note to turn off NMEA message on base/rover radio ports. Activate only \$JASC,DFX on base and set rover to \$JDIF,RTK.

Rev 1.3 April 2009

- EGNOS Inmarsat 4f2 to replace 3f5 on PRN 126 (PRN 124 set to broadcast). (Update Fig C4 and Table C1 of AppC)
- Change link to Lyngsat Tracker for PRN 126 (AppD)
- New EGNOS RIMS added (change AppC Fig C-2)
- Add EGNOS user support link (Update EGNOS web site AppD): <http://194.224.177.81/Webportal/Egnos/Pages/Home.page>

Rev 2.0 December 2010

- SXBlue II-B GPS and SXBlue II-L GPS receivers added
- SBAS information updated in Appendix

Rev 2.1 October 2011

- Page 83, OmniSTAR frequency table shows frequencies in KHz
- Added 90 days clause warranty for Li-Ion battery

Rev 2.2 January 2012

- Modified sections 4.7 and 4.8.6 for the Auto-Diff commands

Rev 3.0 October 2017

- New SXblue Platinum series
- MFA and available options
- Atlas L-band services
- SXblue Config Application
- Communication with Android OS, iOS, Windows 10 and Windows Mobile



WWW.SXBLUEGPS.COM